

# newsletter

NEWSLETTER OF THE EUROPEAN LOW GRAVITY RESEARCH ASSOCIATION



NUMBER 10, DECEMBER 2016  
ISSN 2219-5602

## President's page

Dear ELGRA members,

A new year has started and I wish it will bring professional success to all of you. But, it is also time to take a stock of the activities carried out in the past. So, with a well-established biennial appointment, you have received the tenth ELGRA Newsletter, the content of which summarizes the main events and activities organized by ELGRA and its members over the past two years. Moreover, in the Newsletter you will find also announces and information on the new activities and future events.

As you know, the ELGRA Biennial Symposium and General Assembly 2015 were held in the wonderful venue of Corfu Island, in Greece. I want to thank Prof. Thodoris Karapantsios, who took care of the local organization of the Symposium. In accordance with the ELGRA commitment in education, the Symposium offered activities devoted to students, who participated very actively. During the Symposium we celebrated the ELGRA medals 2015: Prof. Günter Froberg and Prof. Rupert Gerzer. According to an agreement between ELGRA and the scientific journal *Microgravity Science and Technology*, some of the interesting papers presented in Corfu have been published in a special MSTJ issue devoted to the ELGRA Biennial Symposium 2015.

Before Christmas Holidays you received the announcement of our next ELGRA Symposium. It will be held in early October 2017 in the very charming city of Antibes, France. The ELGRA Management Committee decided to change the site of the symposium from the previous choice to Antibes in order to take advantage of the great opportunity to organize it jointly with the International Symposium on Physical Sciences in Space. Therefore, the Joint Conference of the 7th International Symposium on Physical Sciences in Space (ISPS-7) & 23rd European Low Gravity Research Association Symposium, is organized by ESA (European Space Agency) and ELGRA (European Low Gravity Research Association) and co-organized by IMSPG (International Microgravity Science Strategic Planning Group).

The joint ISPS-7 and ELGRA-23 Conference aims to be a major International Scientific Forum for scientists involved in physical and life sciences research in the space environment. The intention of the organizers is to inspire discussion between physical and life science communities and encourage collaboration for new interdisciplinary projects. I kindly ask the ELGRA members from physical and life sciences to attend the Conference and give their important contribution for the success of the event.

In the year 2016 it was held the first edition of the ESA-ELGRA Summer School, co-organized by the ESA Academy and ELGRA with the aim to promote gravity-related research amongst future scientists and

attract them to the multiple research opportunities available in the space sector.

From June 27th to July 1st 2016, at the ESA Academy's Training and Learning Centre located at ESA Redu centre in Belgium, twenty-two bachelor and master students from nine European countries attended the lectures on physical science, life science, and human physiology given by ELGRA and ESA experts.

After the success of the first edition (last year, 168 applications were received), the Summer School will be repeated in summer 2017. I take the opportunity to thank the ELGRA members who replied to the call for proposals about lectures for the next ESA-ELGRA Summer School.

Also new in 2016 was the establishment of the ELGRA Research Prize. It is aimed at offering a financial support up to 10.000 euros to a young researcher, PhD students or post-doctoral fellows (not later than 5 years after his/her PhD achievement), for a Physical- or Life Science oriented innovative research program of 1-2 years in the field of micro/hypergravity.

The project should be done in universities or non-profit institutions belonging to one of the European Union (EU) Member States or associated countries. I hope that young ELGRA and SELGRA members will appreciate this initiative and respond to the call for proposal I sent along with my Christmas wishes.

The newsletter offers also an interesting scientific content: it includes reports and papers by ELGRA members, who describe their most important activities and results.

Moreover, I wish to draw your attention to the Positioning Paper on 'Human Spaceflight and Space Exploration in Horizon2020', written by some colleagues after the outcome of the ECs H2020 Space Consultation held in September 2016, in Brussels. The feedback from the scientific community is extremely important for this initiative.

Unfortunately, The Newsletter reports a sad announcement: last year, two very active members of our community, Prof. Eberhard Horn and Prof. Proto Pippia, who have dedicated their life to space biology studies, left us forever.

Concluding, I would like to thank our Vice President, Prof. Valentina Shevtsova, for the great job done as the editor of the tenth ELGRA Newsletter.

With my best wishes,

Monica Monici  
ELGRA President  
ASAcampus JL, ASA Res. Div.-Univ of Florence  
Florence, Italy

## Contents

The Corfu Meeting 2015	3
Opinion	5
In focus: JEREMI	7
In focus: DCMIX3	10
Future experiments	11
Science	14
Student's presentations	23
ESA education	27
ESA/ELGRA academy	29
ELGRA Student Organization	31
ELGRA Publishing	33
Obituaries	34
ELGRA meeting	36

## Editor:

Dr. Valentina Shevtsova

## Editor Assistant:

Dr. Denis Melnikov

Free University of Brussels (ULB), Av. F. Roosevelt 50, 1050 Bruxelles BELGIUM  
vshev@ulb.ac.be

[www.elgra.org](http://www.elgra.org)

ELGRA - Registered in Munich, Nov 22, 1979  
Vereins-Register number 9702

The European Low Gravity Research Association (ELGRA) is a non-profit international society devoted to the promotion of scientific research under various gravity conditions in Europe. The organization, established in 1979, provides a networking platform for all scientists interested in life and physical sciences and technology in space or on ground.

**The members and the addressees of ELGRA are:**

- Scientists at universities working in microgravity
- Scientists of non-educational research organizations working in microgravity
- Managers and engineers from agencies and industries

**ELGRA aims:**

- To represent and strengthen the scientific community of altered gravity research
- To involve young people in research on these topics by educational programs

**ELGRA is especially committed with students and young scientists:**

- Accepting student members exempt from paying any membership fee
- Providing them financial support to attend meetings and courses
- Organizing a student contest and a student session in ELGRA meetings across Europe

### ELGRA Membership

Become an ELGRA member and strengthen our community! The following annual fees apply.

Students	free
Regular member	€ 50
Supporting member	€ 600

For further information and to download the application form, please visit the ELGRA web site at [www.elgra.org](http://www.elgra.org).



The ELGRA Biennial Symposium and General Assembly *FROM PYTHAGORAS TO FREE FALL* took place from September 29 to October 1, 2015 in Corfu Island (Greece). The event was attended by 89 participants from 20 different countries. The local organizing committee was led by Prof. Thodoris Karapantsios from the Faculty of Chemistry in the Aristotle University of Thessaloniki, Greece.



Participants at the Gala dinner at the Achilleion Palace.

An extensive series of topics was presented by experts and scientists from all over the world. For Physical Sciences, the main topics were

- Vibration,
- Experiments at ISS,
- Diffusion,
- Instability,
- Two-phase flows and Thermocapillarity.

The Life Sciences sessions were devoted to

- Cell biology,
- Facilities,
- Immune Cells,
- Plant Biology,
- Physiology and Fluid Physics.

Additionally, a joint session that combined both disciplines of Physical and Life Sciences took place at the last day of the Symposium. At that session, the potential of the International Space Station and the new Airbus A310 ZERO-G to function as platforms for future microgravity experiments was extensively discussed. Moreover, there was a lively poster session including 34 poster presentations.

Plenary lectures were presented by

- Prof. Kiriaki Chrissopoulou from the Institute of Electronic Structure and Laser of Crete, Greece

- Prof. Jack van Loon from the VU-University Medical Center, Amsterdam, The Netherlands
- Prof. Rupert Gerzer from the Institute of Aerospace Medicine, German Aerospace Center
- Prof. Günter Froberg from the Institute for Metals Research, TU Berlin, Germany

The ELGRA medals were awarded to *Prof. Rupert Gerzer* for his outstanding work in the field of space physiology and space biology as well as to *Prof. Gunter Froberg* for his highly recognized diffusion experiments on different vehicles in microgravity.



Student contest awards during the Gala dinner at the Achilleion Palace.

The student competition was an essential and emblematic feature of the Symposium. Five winners of the student contest received a sponsorship from ELGRA and five other students received a sponsorship from ESA.



A Greek dancing lesson at the Welcome party.

At the first day of the Symposium, a Welcome party was held at the venue hotel, offering a superb view of the beautiful Ionian Sea landscape whereas Greek dancing lessons were delivered to joyful volunteers. At the end of the second day, the participants enjoyed



a short boat trip from the venue hotel across the bay to a marvelous nearby hill overlooking the coast line where a dinner took place under the moonlight with traditional recipes of Corfu. The last day of the Symposium included a narrated visit to Achilleion Palace, built by Empress Elisabeth (Sisi) of Austria. The visit was followed by a Gala Dinner at the Palace gardens, among statues and fountains, where a broad variety of local and international dishes was offered. The dinner climaxed with a vivid dancing session where ELGRA participants proved, once more, that earth's gravity is not enough to subdue their moves and leaps.

The efforts of many people involved in the organization of the

22nd ELGRA Biennial Symposium & General Assembly, allowed a productive and enjoyable meeting that offered the opportunity to discuss scientific achievements in microgravity research in the beautiful location of Corfu. A special note of thanks goes to the members of the local organizing committee, Dimitris Ganitis (NB events), Sotiris Evgenidis and Ourania Oikonomidou (Aristotle University of Thessaloniki, Greece) for their contribution to the organization of the Symposium. The European Space Agency is especially acknowledged for the continuous support of ELGRA as well as for sponsoring the student contest at the ELGRA Biennial Symposium 2015.



Photo of the participants.

Announcement of the  
**The Joint Symposium ELGRA-25 & ISPS-7 (International Physical Sciences in Space)**

October 2–6 , 2017

Conference Centre of Antibes, Antibes, Juan-les-Pins, France

for further information, please visit [www.elgra.org](http://www.elgra.org)

## Letter to ELGRA members

Dear Colleagues,

Stimulated by the outcome of the ECs H2020 Space Consultation in September 2016, in Brussels, and as presented at the Analogue Workshop on the 12th October 2016 at the Research Executive Agency, also in Brussels, we would like to ask you to feed-back and support our Positioning Paper. It was written to complement the existing H2020 Space Work Programme with Exploration and Human/Robotic Spaceflight topics as there have been in the past and to allow for the continuation of those efforts building on already established expertise. The Paper incl. signature page with the email.

If you support the initiative described in the paper we kindly ask you to return, the signed Letter of Support as attachment to either:

Peter Weiss, COMEX; p.weiss@comex.fr  
 Richard Aked, Space Applications Services,  
 richard.aked@spaceapplications.com  
 Barbara Imhof, LIQUIFER Systems Group,  
 barbara.imhof@liquifer.com

## Position Paper Human Spaceflight and Space Exploration in Horizon2020 and beyond

### Introduction

H2020 and its space programme are intended to ensure "Leadership in Enabling and Industrial Technologies". It aims to achieve this by building on past research, allowing the citizens of Europe, industry, and researchers (primarily in the short and medium term), to reap the benefits.

The overwhelming focus of the current work programme (2016 to 2017) is Earth Observation, Navigation, and some selected specific technologies. The very significant benefits to Europe's citizens, industry and the establishment of international partnerships that can be brought by human spaceflight and exploration activities seem not to be addressed by this programme anymore.

### Context

Europe is a world leader in human spaceflight and exploration technology and has an objective to be a valued partner in the global exploration effort. The capabilities that have been established in Europe, with funding from the ESA, the EC, and national agencies, as well as the associated international collaborations, form the foundation upon which to achieve commercial and research success with international partners.

A new market is emerging: for low-Earth-orbit (LEO) human spaceflight, including on-orbit research, development and its commercialisation as well as transportation. The future commercial space exploration market will be based on those successful in this LEO market place.

It is not often that a new market emerges for which Europe already has significant capabilities, that has a vast potential for growth and will provide industrial, research and international partnership benefits.

### What can the EC H2020 Space Work Programme do?

In an increasingly commercial<sup>1</sup> low-Earth-orbit and planetary exploration market, the EC's H2020 programme can support the establishment of focused and specialised world-class industrial and research capabilities, that leverage the previous 20 years of human spaceflight technology development and know how, as follows:

#### What

- Maximising industrial and scientific returns by use of the International Space Station infrastructure:

"Most of the technologies developed to serve the ISS programme have already found applications in other space projects, attracting new investments toward European space companies and therefore enabling additional revenues." The commercialisation of low-Earth-orbit can only be achieved by innovative developments and it is here that the H2020 Work Programme can make a significant contribution. For example, industries in the United States are already preparing to take advantage of the run-down of the ISS and its transition to a commercial low-Earth-orbit facility. Similarly, the ISS offers many unique opportunities for scientific research which should be taken full advantage of, while it is still available. Given this context, Europe should gain and exploit a leading position in low-Earth-orbit commercialisation.

- Habitats and habitation systems:

Europe has renowned expertise in the development of space habitats, which manifests in its successful participation in several modules of ISS, ATV and SPACELAB. This heritage provides a basis to realise a major commercial and technical partnership, in the development of future habitation modules. The opportunity is beyond collaboration with the United States of America and could include Russia, which recently has authorised the development of its human transportation exploration spacecraft; India, which is building a crew capsule; and China, which is establishing its own space station and is planning to land humans on the Moon by 2036. Given this context, we in Europe need to position ourselves to be a needed partner in habitation module development.

- Environmental Control and Life-Support Systems (ECLSS):

One of the most rewarding research fields leading to terrestrial spin-off applications is the development of ECLSS. The monitoring of the environment, closed-loop life support systems, the detection or prediction of contaminants, the regeneration and filtration of water and air are not only necessary in confined space habitats but can be applied on Earth in hospitals, submarines or simply everyday persons households. Europe has a solid expertise in the development, testing and use of such systems. Previous EC calls in this field led to a strong over-subscription of proposals from the community to which only one or two projects could be awarded. In the current set-up of the H2020 Work Programme, there is no continuation in funding, causing a major interruption in this highly innovative field of research.

- Human-Robot cooperation:

Space exploration will be performed by robots and humans working together in an appropriate cooperation where best use is made of the capabilities of each. The development of collaborative systems (human, software and hardware) that are able to work together in an intelligent manner will be required and should be amongst the ECs research priorities. This field will directly lead to spin-off applications here on Earth for medical robotics, aids for an aging society or search-and-rescue robotics. Previous calls by the European Commission included calls related to this field and should continue in the coming calls of Horizon 2020 and beyond.

- Test, validation and demonstration of technologies for commercial space and space exploration:

Developments in the space sector require extensive test and validation activities in dedicated facilities, through analogue and In-situ Resource Utilisation (ISRU) tests and on-orbit demonstrations. Currently only relatively expensive in-orbit demonstrations and validations are covered by the Work Programme. Less costly analogue tests, however, could in many cases be more than adequate and are readily accessible. Europe has a small analogue infrastructure, covering LEO, lunar and Mars, but an enviable capability and reputation for high quality engineering and research. The further development and use of these analogues by industry and research entities should be encouraged and their use on a commercial basis, also by other nations, encouraged.

### How

Considering that Europe has ambitions to be a valued partner of space exploration and also that exploration, that is starting now, will continue for decades, activities preparing the way for Europe beyond ISS, should be envisaged by the European Commission.

- Workprogrammes of H2020 and FP9:

Developments in this area should be two-fold: on the one hand through calls in the upcoming Work Programme of H2020 and then further in the FP9 to continue efforts for broad and curiosity driven research and development to create, demonstrate and validate a focussed set of technologies that are promising candidates for use by ESA and/or for commercialisation. This approach would ensure no overlap and a complementarity between both agencies.

- Human Spaceflight and Exploration Strategic Research Cluster (SRC):

A SRC on Human Spaceflight should be implemented reflecting selected aspects of the consolidated research roadmap similar to the existing ones on Robotics (PERASPERA) and Electric Propulsion (EPIC). This is also a recommendation of the European Science Foundation at the September 2016 EC consultation meeting. Such an SRC could potentially be jointly managed by ESA (European Space Technology Research Centre/European Astronaut Centre) and the EC.

### When

We believe that the above mentioned themes should be addressed in the future work programme of Horizon 2020 and thereafter.

- How could this be achieved?

1. By including the above proposed subjects as a priority in the calls, focusing on continuity of past and on-going activities
2. Provide complementary opportunities for curiosity driven research (low TRL)
3. In parallel, set up a Human Spaceflight Strategic Research Cluster (higher TRL)

- What would be the expected benefits for Europe?

The direct benefits to Europe will include establishing a place in the emerging commercial low Earth orbit and exploration market, with its vast economic and scientific rewards. Of all the subjects that could be addressed by the H2020 Space work programme this subject would be one which focuses on people, i.e. humans. Human Spaceflight will provide direct benefits for Europe's citizens from increasing our understanding and capabilities in human health, ageing and medicine, in environment, water, air quality, pollution management and in establishing workable human-robot collaboration experience, all of which are key issues for improving life and well-being on Earth.

This initiative would grow the emerging commercialisation of LEO space in Europe. Furthermore, human spaceflight, astronauts and exploration inspires citizens and children encouraging future generations to want to study and work in science.

The current programme is called "Horizon 2020". On this horizon emerges the finalisation of ISS and the voyage towards new targets in the solar system. The European Commission, together with ESA, should work on the fulfilment of this new, promising era of commercial space and space exploration. If you support the above described initiative we kindly ask you to return, the signed Letter of Support

### Comments

*The ISS as a science platform : The wealth of data from previous scientific experiments both within and outside the ISS clearly documents its value as a science platform having unique environmental characteristics. The very nature of these unique characteristics—combinations of vacuum, more or less lack of gravity, extreme temperature ranges, extreme radiation conditions – means that they cannot be satisfactorily imitated in laboratory conditions on Earth. Thus, the ISS provides an extremely valuable science vehicle to the science community. Frances Westall, 15.2.2017*

*EC grants are the only platform where multi- and cross-national research is supported in Europe. This is not possible for e.g. ESA. This is a strong argument for EC projects; it brings scientists together on a European scale. Jack van Loon, 20.2.2017*



**Advancements in understanding Marangoni instabilities and particle accumulations under  $\mu$ -g conditions**

Romanò F.<sup>1\*</sup>, Kuhlmann H. C.<sup>1</sup>, Melnikov D.<sup>2</sup>, Gaponenko Yu.<sup>2</sup>, Yasnou V.<sup>2</sup>, Shevtsova V.<sup>2</sup>, Herrada M. A.<sup>3</sup>, Montanero J. M.<sup>4</sup>, Yano T.<sup>5</sup>, Nishino K.<sup>5</sup>,

<sup>1</sup>Institute of Fluid Mechanics and Heat Transfer, TU Wien, Getreidemarkt 9, Tower BA/E322, 1060 Wien, Austria,

<sup>2</sup>Université Libre de Bruxelles (ULB), MRC, CP-165/62, 50, Ave. F.D. Roosevelt, B-1050 Brussels,

<sup>3</sup>Departamento de Ingeniería Aeroespacial y Mecánica de Fluidos, Universidad de Sevilla, E-41092 Sevilla, Spain,

<sup>4</sup>School of Industrial Engineering, University of Extremadura, Badajoz, Spain,

<sup>5</sup>Department of Mechanical Engineering, Yokohama National University, 79-5 Tokiwadai, Hodogaya-ku, Yokohama, Kanagawa 240-8501, Japan, Email: francesco.romano@tuwien.ac.at

The collaboration between Japanese and European researchers, started with the project *Marangoni instabilities in systems with a cylindrical symmetry*, has lead in 2007 to establish the TT JEREMI (Japanese European Research Experiment on Marangoni Instabilities). The teamwork of scientists involved in this project investigates a differentially heated liquid bridge assuming it as paradigm of systems subject to Marangoni instabilities. The liquid bridge is coaxially surrounded by a stream of external gas which can be suitably controlled. The JEREMI project consists of two parts: (a) a preliminary study based on ground experiments, numerical simulations and theoretical studies conducted in Japan and in Europe (Austria, Belgium, Germany, Spain, and Italy) and (b) the launch of an experimental campaign which will be carried out in FEPF module of KIBO with the support of ESA and JAXA.

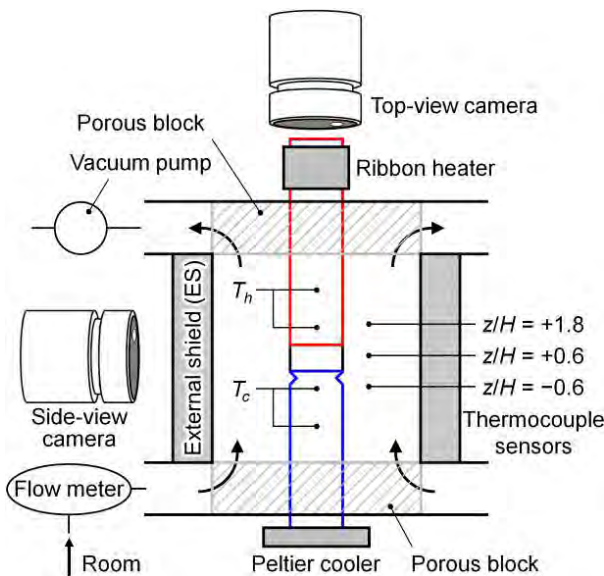

Figure 1: Experimental set-up to study the convective heat transfer effect on the instability in a liquid bridge.

The TT JEREMI is aimed at understanding (a) the heat transfer

phenomena and the hydrodynamic oscillatory instabilities correlated to the deforming interface between the liquid bridge and the surrounding gas and (b) the rapid de-mixing and the consequent accumulation of particles along closed threads in the liquid bridge is addressed as PAS (particle accumulation structures). The JEREMI research has practical applications in the production of high-quality crystals, fibers and micro-fibers, semi-conductors, micro-jets, plus it gives the chance to study a relatively new phenomenon of particle accumulation.

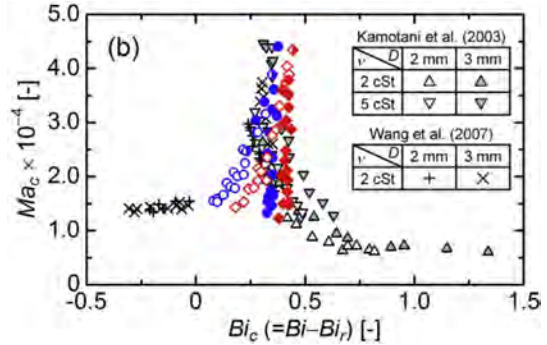

Figure 2: Critical Marangoni number ( $Ma_c$ ) for the onset of instability plotted as a function of Biot number,  $Bi$ . Blue markers depict Prandtl number  $Pr = 28$  and red diamonds  $Pr = 67$ .

A first investigation on the heat transfer across the liquid-gas interface has been carried out focusing on convection and radiation. Such a study is aimed at clarifying the effect of the ambient gas motion on the instability of thermocapillary convection in liquid bridges made out of high Prandtl number liquids. Figure 1 shows the experimental set-up for a ground experiment, where air stream is introduced into the annular gap between the liquid bridge and the external shield in order to vary the convective heat-transfer rate. It is found that the critical Marangoni numbers for the onset of instability are well correlated with the Biot number corresponding to the rate of convective heat transfer (Fig. 2) [1].

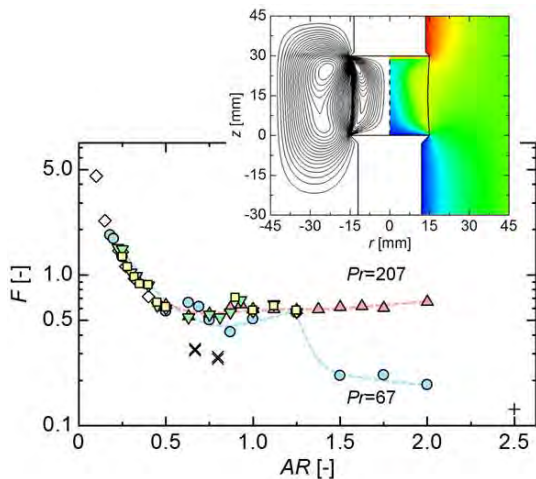

Figure 3: Dimensionless frequency ( $F$ ) detected at the onset of oscillation in liquid bridges of high Prandtl number liquids experimented in microgravity environment on the ISS.

Microgravity data taken on the International Space Station are analysed to clarify the mechanisms of the onset of oscillation in liquid bridges. It is found that the dimensionless oscillation frequency plotted as a function of the aspect ratio ( $AR = \text{length}/\text{diameter}$ ) of the liquid bridge is dependent on the Prandtl number and that this dependence for long liquid bridges is strongly correlated with the computationally evaluated rate of heat transfer from the liquid-bridge surface (Fig. 3) [1].

Further investigations have been experimentally carried out on flow stability in a liquid bridge whose interface is surrounded by gas with well-controlled temperature. The experiments are conducted under ground gravity conditions. The stationary flow appears at arbitrary values of imposed temperature difference  $\Delta T$  due to thermocapillary stresses and evolves under the action of both Marangoni and buoyancy forces. The appearance of oscillatory flows depends on the velocity and temperature of the surrounding gas as well as the mean temperature of the liquid. The experimental observations are supported by two-phase non-linear numerical simulations taking evaporation into account (Fig. 4).

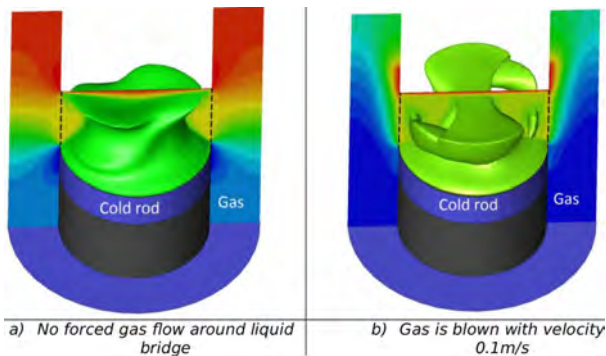

Figure 4: Computed temperature field in liquid bridge filled with n-decane and air as gas;  $\Delta T = 7.4K$ ,  $T_{\text{mean}} = 298K$  and  $T_{\text{gas}} = 293K$ . Iso-surfaces of the mean temperature inside the liquid are shown by green colours. The temperature field in gas phase is illustrated by colors.

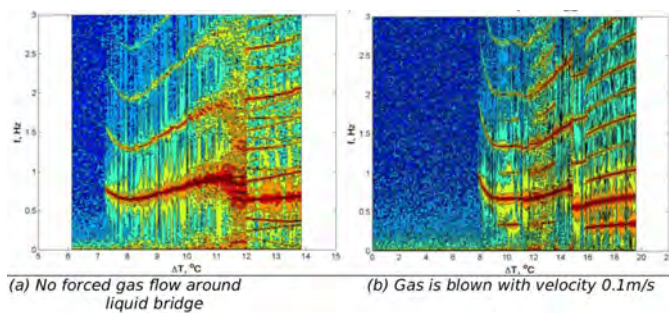

Figure 5: Experimental Fourier map. The experiment starts from  $\Delta T$  below critical value and then temperatures difference gradually increases. For each given  $\Delta T$  the Fourier spectrum is built and then they are combined in a map presented here.  $T_{\text{mean}} = 298K$  and  $T_{\text{gas}} = 293K$

The working liquid (n-decane) is weakly evaporating. In the experiments with no-forced flow, the coaxial gap around the liq-

uid bridge is large, thus, vapour diffusion is not the rate-limiting mechanism for evaporation (results are given in Fig. 5a). In the experiments with forced gas flow, due to experimental constraints the liquid bridge is surrounded by co-axial tube of smaller diameter (results are given in Fig. 5b). It can be seen from Figs. 4 and 5 that moving gas affects not only the critical parameters,  $f_{cr}$  and  $\Delta T_{cr}$ , but also the change of flow states in supercritical regime.



Figure 6: Images of the liquid bridge oscillation the experiment *Dynamic Surf*. The images were kindly provided by Dr. Satoshi Matsumoto.

Another issue connected to the experiments on the International Space Station is uniquely referred to  $\mu$ -g. Under micro-gravity conditions a small fluctuation of the gravitational field can be responsible for g-jitter phenomena. One of the key aspects of the experiments planned in JEREMI is the control of the liquid bridge oscillations caused by g-jitter on board of the ISS. An analysis has been carried out to interpret the surprisingly large oscillations (see Fig. 6) observed aboard the ISS during the experiment *Dynamic Surf*, conducted on April 23th 2013 in the Fluid Physics Experiment Facility of the Japanese Experiment Module (Kibo). The liquid bridge dynamics was calculated by integrating the full (non-linear) Navier-Stokes equations using as input the data acquired by the accelerometers. The appearance of those oscillations has been explained in terms of a very small-amplitude vibration of the experimental set-up at the first  $m = 1$  resonance frequency.

In addition to controlling the flow in thermocapillary liquid bridges, the JEREMI experiment provides the opportunity to study particle accumulation structures (PAS). Particles of small size are initially randomly distributed in the liquid bridge. Under specific conditions for flow and particle parameters it is observed a rapid de-mixing between solid and fluid phase which leads to particle structures to emerge after relatively short time. Their formation time depends on properties of both particles and fluid flow.

Some features of the particle-laden flow cannot be captured experimentally, and the researchers are performing a complex computer modelling for reproducing the major features of the phenomenon, interpreting experimental observations and verifying their hypotheses. Very good agreement was obtained between the calculations and the experimental data. Not only the structures were perfectly reproduced but their correlation with the flow was disclosed, as Figs. 7 and 8 illustrate. The formation time of structures predicted by the computational model was in good agreement with the experimental data as Fig. 9 proves.



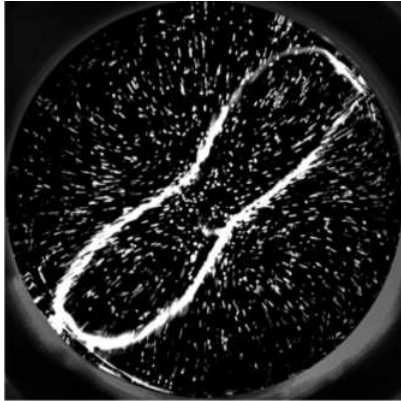

Figure 7: Experimental observation. A top-view through a transparent upper disk of particles distribution (seen as white specs) in a liquid bridge with a cylindrical interface.

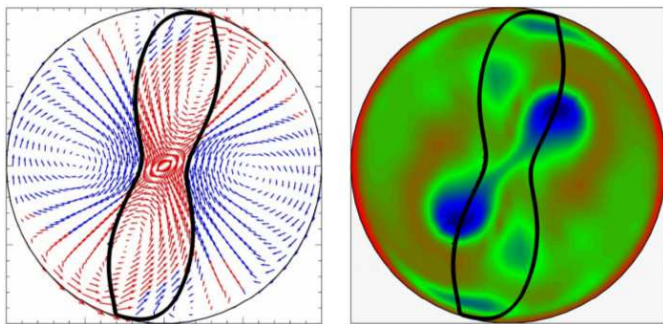

Figure 8: Computer modelling of the experiments. Top view of particles distribution (seen as black symbols) in a liquid bridge. The particles form a stable symmetric coherent structure whose correlations with velocity (temperature field) are shown on the left (right) panel.

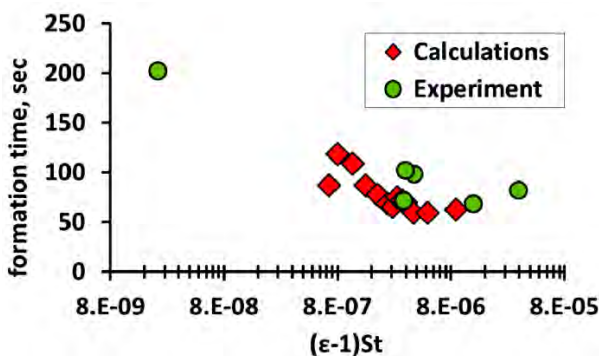

Figure 9: Comparison between results of the computer modelling and of the experiments. Formation time of coherent structures is plotted versus inertia of heavy particles, which is  $(\epsilon - 1)St$ , where  $\epsilon$  is the particles to liquid density ratio, and  $St$  is the Stokes number – the ratio of the characteristic time of a particle to a characteristic time of the flow.

One the contrary of other mechanisms inducing accumulation, i.e. buoyancy and sedimentation, PAS are experimentally observed and numerically reported in laminar flows also under weightlessness conditions. Therefore a simplified theoretical model has been proposed for explaining the reason of accumulation based on the finite size of the particles (see Fig. 10). Owing to lubrication forces which repel the particles from the liquid bridge free-surface, they are transferred from chaotic to regular regions of the flow and, once attracted, they remain trapped. The particle accumulation is therefore induced by the particle–boundary interaction and possible only if such regular regions of the flow are close enough to the boundaries. The same PAS phenomenon, discovered and reported for the first time in liquid bridges by Schwabe et al. [3], has recently been observed in other systems. In all the reported cases, employing such a particle–boundary interaction model with an accurate prediction of  $\Delta$  leads to very good agreement between numerics and experiments, whereas, without it, no accumulation is found by numerical simulations.

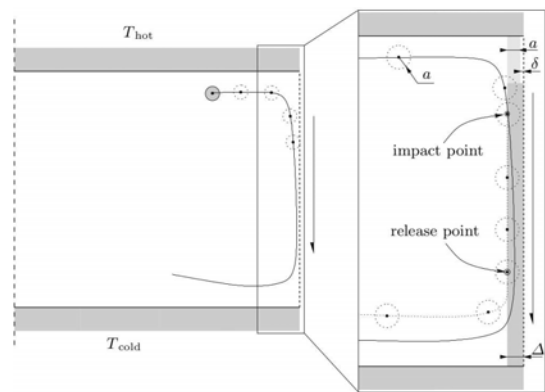

Figure 10: Sketch of the theoretical model applied to a spherical particle in an axisymmetric liquid bridge. The full line represents the trajectory if particle–boundary model is enforced, whereas the dotted line shows the trajectory if the collision between particles and free-surface is theoretically modelled.

References

[1] Yano, T., Maruyama, K., Matsunaga, T., Nishino, T., Effect of ambient gas flow on the instability of Marangoni convection in liquid bridges of various volume ratios, *International Journal of Heat and Mass Transfer* 99 (2016) 182–191  
 [2] Ferrera, C., Herrada, M. A., and Montanero, J. M., Analysis of a resonance liquid bridge oscillation on board of the International Space Station, *European Journal of Mechanics B/Fluids* 57 (2016) 15–21.  
 [3] Schwabe, D., Hintz, P., and Frank, S., New features of thermocapillary convection in floating zones revealed by tracer particle accumulation structures (PAS), *Microgravity - Science and Technology* 9(3) (1996) 163–168.

## The DCMIX3 Campaign of the ESA/Roscosmos DCMIX Project

Köhler W.<sup>1\*</sup>, Triller T.<sup>1</sup>,

<sup>1</sup>Physics Department, University of Bayreuth, Germany

The composition of a liquid mixture does not stay uniform once a temperature gradient is applied. This effect was first described by Ludwig in 1856, only one year after Fick's fundamental work on diffusion. The first systematic investigation was conducted as early as 1879 by Soret. Despite this long history, there are many open questions left, and a comprehensive molecular theory of this so-called Soret effect is still missing. For many systems, not even the sign of the Soret coefficient, which serves as a measure for the magnitude of the composition change that is induced by a prescribed temperature difference, can be predicted.

Although the concept appears to be rather simple, reliable experimental data are not easily obtained. In particular in mixtures where the heavier component migrates to the hot side, the stratification of the liquid can be perturbed by gravitational convective instabilities – a problem that becomes even more severe in case of ternary instead of binary mixtures. The systematic study of the latter has been intensified in recent times, after the development of modern multicolor optical detection schemes. Such ternary mixtures can be regarded as prototypes for systems of practical interest that typically contain more than just two components: colloidal dispersions, polymer solutions, biological fluids or oil reservoirs, to mention only a few.

With the aim to establish reliable and guaranteed convection-free reference data for ternary mixtures, the ESA/Roscosmos project DCMIX has been established with participating research groups from Belgium, Canada, France, Germany, Italy, Japan, Russia, and Spain. In a number of experimental campaigns different ternary liquid mixtures have been and will be investigated in the SODI apparatus on-board the International Space Station ISS. These so-far quite successful space experiments have spawned numerous laboratory experiments on ground and a very fruitful and intense collaboration between the participating researchers. It is certainly valid to say that today's research on thermodiffusion of ternary mixtures is mainly driven by the DCMIX project and the numerous spawned satellite ground based works, which also comprise fundamental considerations on the measurability of transport coefficients of multicomponent mixtures by optical means [1].

### The DCMIX3 Campaign

The third experimental campaign, DCMIX3, has been conducted from September until November 2016. The six sample cells contained five different ternary mixtures of water, ethanol, and triethylene glycol and a binary mixture of water and ethanol. These

mixtures are of particular interest, since they show both convective instabilities and sign changes of the Soret coefficients. DCMIX3 has been coordinated by the Bayreuth group of Werner Köhler and his student Thomas Triller. The actual space experiments have been operated by the skilled E-USOC Team of Ana Laveron in Madrid, where the science team from Bayreuth spent some time already in June 2014 for a familiarization campaign. After a catastrophic launch failure in October 2014, the samples were successfully delivered in July 2016 by the Space-X CRS-9 mission. The figure shows the installation of the SODI digital interferometer with the sample cells in the microgravity science glovebox by NASA astronaut Kate Rubins. During the campaign, first promising data were obtained via telemetry, but now the team is waiting for the complete datasets to be brought down to earth on hard disks.



NASA astronaut Kate Rubins during setup of the SODI instrument with the DCMIX3 cell array in the microgravity glovebox MSG (NASA image).

The DCMIX3 campaign, and the DCMIX project in general, is an excellent example for successful cooperation between many researchers and institutions involved. Besides, of course, ESA and Roscosmos and the joint efforts of the entire DCMIX team, we want to emphasize in particular the very efficient support by E-USOC and the valuable transfer of previous experience by the DCMIX2-team of Valentina Shevtsova and Aliaksandr Mialdun. The immediate analysis of acceleration data from the ISS by Xavier Ruiz and Josefina Gavalda allowed us to identify an acceleration spike as the cause of a sudden image shift in the interferometer. The preparation of the DCMIX3 samples and the accompanying lab experiments would not have been possible without support by the German Aerospace Center DLR.

### References

- [1] M. Gebhardt, W.Köhler. What can be learned from optical two-color diffusion and thermodiffusion experiments on ternary fluid mixtures? *J. Chem. Phys.* 142 (2015) 084506.



Swedish Space Corporation

Lockowandt C.<sup>1\*</sup>,  
<sup>1</sup>Swedish Space Corporation, Sweden

MAXUS-9 microgravity rocket



MAXUS-9 Payload

The next microgravity sounding rocket mission, MAXUS-9, is planned to be launched this spring on 2 April 2017 from the Esrange Space Centre just outside of Kiruna, Northern Sweden. It will be carrying four experiment modules covering research in material science, combustion and biology. This is the ninth mission

using a MAXUS sounding rocket, and will provide 12-13 minutes of weightless conditions to the more than 800kg of payload. Sounding rockets are a key platform for research within ESA's Directorate of Human Spaceflight providing an important, cost-effective and independent means for Europe to carry out research requiring access to short-term periods of weightlessness with a relatively quick turnaround of results, as well as providing precursor testing to research equipment which could eventually be launched to the International Space Station.



MAXUS on launch pad

The MAXUS sounding rocket programme is performed by an industrial joint venture between Swedish Space Corporation and Airbus DS. The program is funded by ESA through the European Programme for Life and Physical Science in Space (ELIPS).

Launch to landing of the single stage MAXUS sounding rocket will take only 26 minutes. The sounding rocket has a mass of 12.3 tonnes when it lifts off from the launch pad at Esrange. The scientists will be able to monitor and control their individual experiments on board. The information they receive will be complemented by the data safely embedded in the experiment modules to be retrieved after landing.

After about 60 seconds after lift-off the solid fuel rocket motor will finish burning and separates from the payload section. The Rate Control System with its nitrogen thrusters is now activated to stabilise the payload and provide for optimal weightless conditions.





MAXUS payload after landing

The payload continue the ascent for another six minutes to an altitude of around 750 km (around twice the altitude of the ISS) before the descent back to earth. At around 14 minutes after launch the weightless phase is finished. The Rate Control System thrusters are again activated and the payloads are placed in the correct orientation for re-entry. At almost 15 minutes after lift off the MAXUS enters the atmosphere travelling at around 4.5 km/s (Mach 13). The speed of the payload is decreased by the air friction in the atmosphere at about 5 km the main parachute opens to slow further down the MAXUS payload to allow it to make a soft enough landing in the snowy tundra region north of Esrange where it is retrieved around an hour after landing.

### XRMON-Diff2

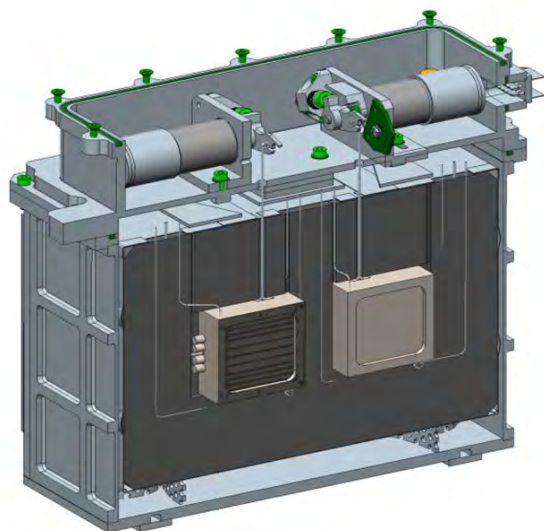

Furnace assemble with the two furnaces in the middle and the shearing system on top for moving sample parts in furnace.

This experiment module is developed and build by SSC and the Principle Investigator is Prof. Florian Kargl, DLR, Colonge, Germany. The experiment will investigate the diffusion process in different metal samples in microgravity. The experiment will fly on the MAXUS 9 mission.

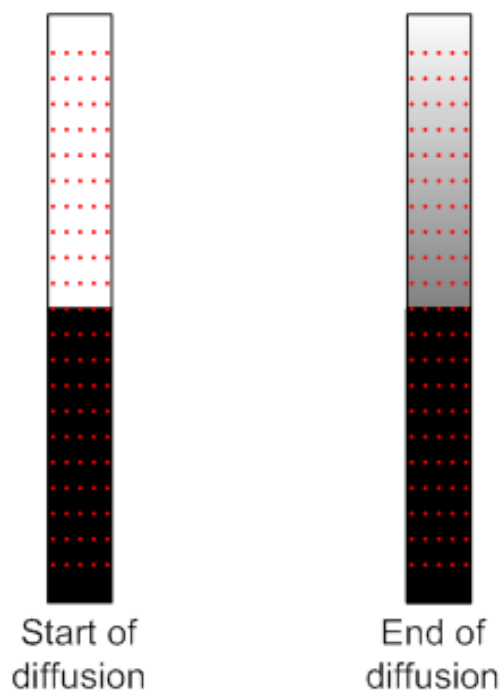
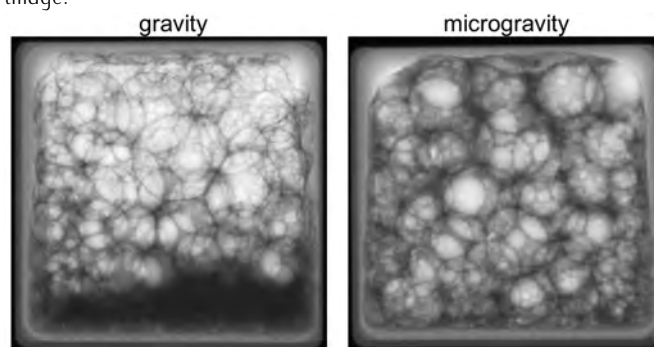

Image of metal samples illustrating the diffusion process, start and end of process.

The module is equipped with two high temperature furnaces with four metal samples in each furnace. The samples in the alumina furnace are composed of AlTi with a melting point of 1560°C. The samples in the graphite furnace are composed of SiGe with a melting point of 1200°C. The furnaces are contained in an insulated and evacuated compartment. The samples are heated up and melted before lift off and at start of microgravity the samples are sheared in the middle to start the diffusion process.

The diffusion process is studied in situ during the complete microgravity phase, lasting approximately 12 minutes, with an x-ray system. An x-ray image of the samples is captured each second during the microgravity phase. In the x-ray images of the samples the diffusion process can be studied by observing how the material in one of the two sample parts diffuses in to the other part, see image.



X-ray images of metal foam.

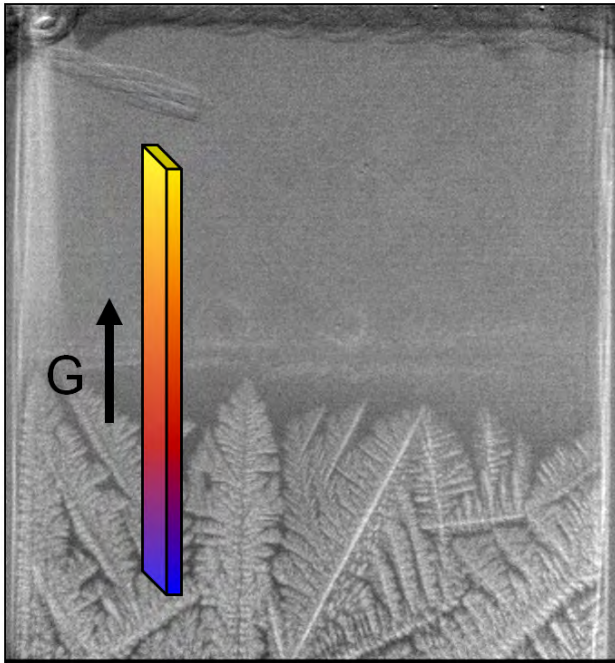

X-ray image of solidification in microgravity of Al<sub>20</sub>wt %Cu, temperature gradient indicated.

**Curious about what happens on the inside of your experiment? X-ray monitoring may be the answer!**

During the last 10 years SSC has had the privilege to develop a series of instruments for material science using real-time in situ continuous X-ray monitoring of solidification processes. The experiences gained have shown that modern compact X-ray components are quite possible to adapt for usage in a low gravity environment. Our experiences so far is within the field of material science such as metal foam generation solidification process, diffusion experiments, but the technology can as well be used for other areas such as biology. As long as the materials have a suitable thickness a short enough exposure time can be used to prevent motion blur, and a high enough difference in absorption of radiation to provide contrast, almost anything can be observed. Since digital cameras can be adapted for X-ray operation a wide selection of parameters is possible. Depending on the required detail, image size and exposure time different image speeds can be selected. Some examples of in situ real time X-ray observation: The formation and response of metal foams in low gravity, normal gravity and ultra gravity (experiments in the lab, on sounding rocket and in parabolic flight). Images show in real time how a dry metal foam is formed in microgravity, liquid part separation in ultra-gravity and reflux of liquid in microgravity.

Experiment Module	Experiment Title & PI
PERWAVES	"Percolating Reactive Waves in Particulate Suspensions" Asso. Prof. A. Higgins, McGill University of Montreal, Canada
GRADE CET	"Gravity Dependence of CET in Peritectic TiAl Alloys" Dr.-Ing. Ulrike Hecht, ACCESS e.V., Aachen, Germany
EUGRAPHO	"Determination of gravitactic threshold in Euglena gracilis after previous microgravity phases" and "An assay to determine the role of cAMP in phototaxis and gravitaxis of Euglena gracilis" PhD Michael Lebert, University of Erlang, Germany
XRMON-Diff2	"In-situ X-ray monitoring of advanced metallurgical processes under microgravity and terrestrial conditions" Prof. Florian Kargl, DLR, Cologne, Germany

Experiments on MAXUS- 9

## Science

### In situ X-ray characterization of Columnar-to-Equiaxed Transition under microgravity and terrestrial conditions

Nguyen-Thi H.<sup>1\*</sup>, Reinhart G.<sup>1</sup>, Zimmermann G.<sup>2</sup>, Browne D. J.<sup>3</sup>, Karma A.<sup>4</sup>, Beckermann Ch.<sup>5</sup>,

<sup>1</sup>Aix Marseille Univ, CNRS, IM2NP, Marseille, France,

<sup>2</sup>ACCESS e.V. & RWTH Aachen, Aachen, Germany,

<sup>3</sup>University College Dublin, Dublin, Ireland,

<sup>4</sup>Northeastern University, Boston, USA,

<sup>5</sup>University of Iowa, Iowa, USA

During casting, the final microstructure in an ingot is the result of the competition between the growth of columnar and equiaxed grains. In general, the ingot can be divided into an outer columnar microstructure (where the growth is preferentially oriented perpendicular to the mold walls) and an inner region (where equiaxed grains are growing in all space directions). The transition from a columnar microstructure to an equiaxed microstructure (CET) is induced by a coupled decrease of the temperature gradient at the solid-liquid interface and an increase of the solidification rate, both depending on the rate of heat removal at the chill. Figure 1 illustrates the CET triggered by a sudden jump of growth velocity applied during columnar dendritic growth. It is well known that the equiaxed microstructure leads to a material with more isotropic macroscopic mechanical properties and a more homogeneous composition field than columnar microstructure. As a consequence, it is critical for industrial applications to precisely understand the physical mechanisms that control this transition, in particular those related to gravity, and its consequences for casting soundness [1].

All open issues concerning the influence of gravity on CET (natural convection, solid phase buoyancy, mechanical effects or variation of hydrostatic pressure) are in essence dynamic and interact intricately with each other [2]. As a consequence, it is of major interest to be able to investigate the time evolution and dynamic selection of the dendritic columnar and equiaxed microstructures. For metallic alloys, post mortem analysis does not provide the interface evolution with time but gives only a "frozen" picture of the final solid microstructure. Therefore, for the study of the CET dynamics in metallic alloys, in situ X-ray imaging is a method of choice, which allows direct observation of the solid-liquid interface or the formation of the equiaxed microstructure in real time, with high image contrast [3].

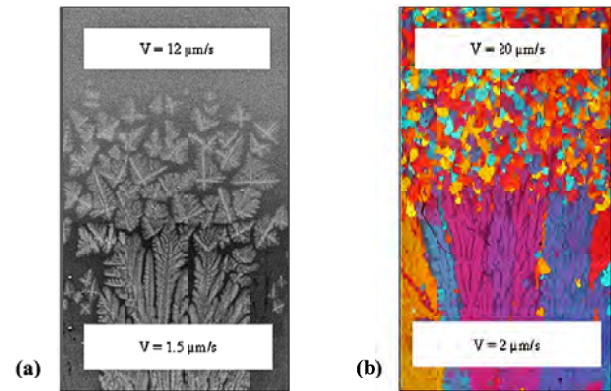

Figure 1: Columnar-Equiaxed Transition obtained by an increase of the growth velocity during the directional solidification of a refined Al - 3.5 wt% Ni. The real width of the two images is 6 mm. (a) In situ X-ray radiograph recorded at ESRF (European Synchrotron Radiation Facility). (b) Optical microscopy image obtained after a post-mortem metallography of the sample.

The aim of the proposed experiment for the sounding rocket MASER-14 is to investigate for the first time the dynamics of the Columnar-to-Equiaxed Transition (CET) in gravity-free conditions with in situ and real-time characterization by X-ray radiography. The ability to apply state of the art in-situ X-ray radiography under microgravity conditions is a real breakthrough in the field and will definitely generate new knowledge on the topic. In situ X-ray monitoring of solidification processes in microgravity conditions is now a mature experimental technique, which was successfully applied to investigate the columnar growth during MASER-12 [4] and ESA parabolic flights [5], as well as equiaxed growth during MASER-13 [6] (see Figure 2). It is proposed to carry out the experiment on an Al - 20 wt% Cu alloy with 0.1 wt% of Al-Ti-B grain refiners, in the XRMON-GF (Gradient Furnace) facility [4]. An accurate experimental timeline would be defined, according to the six-minute microgravity period of the MASER sounding rocket. In the first stage, the sample will be fully melted in the field of view. After a short stabilization period including interface position adjustment, the sample solidification will start with a very slow cooling rate at the two furnace heaters to achieve a columnar microstructure despite the presence of refiners in the melt. As soon as the columnar front will occupy a third of the field-of-view, a second faster cooling rate will be applied at both heaters, which will activate the refiners and thus trigger the columnar to equiaxed transition. In order to enlighten the effect of gravity on the CET, three ground-reference tests would be carried out with the same experimental profile and on a fresh sample, for three different sample positions versus the gravity direction.



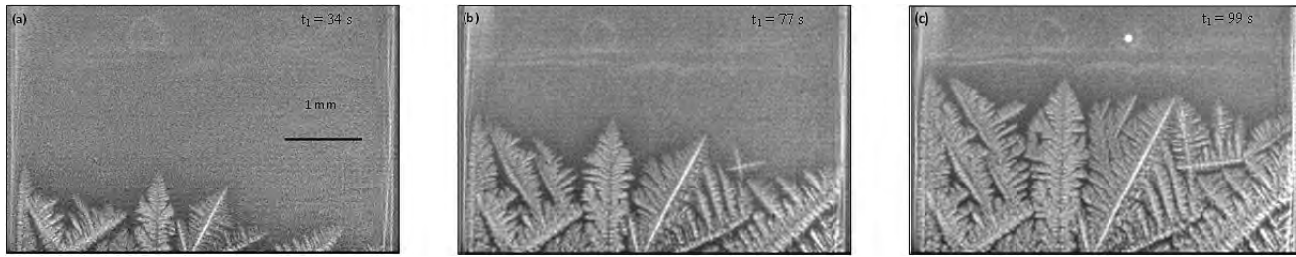

Figure 2: Sequence of three radiographs illustrating the columnar solidification of Al-20wt% Cu in microgravity conditions (MASER-12 experiment), with a temperature gradient of about 150 K/cm and a cooling rate of 0.15 K/s on both heaters.

## References

- [1] G. Zimmermann et al., Columnar-to-equiaxed transition in solidification processing of AlSi7 alloys in microgravity—the CETSOL project, *Materials Science Forum*, 790–791 (2014) 12–21.
- [2] H. Nguyen-Thi et al., Investigation of gravity effects on solidification of binary alloys with in situ X-ray radiography on earth and in microgravity environment. *Journal of Physics: Conference Series* 2011;327:012012
- [3] H. Nguyen-Thi et al, *Comptes Rendus Physique*, 13 (2012) 237–245.
- [4] H. Nguyen-Thi et al., *J. Cryst. Growth* 374 (2013) 23–30.
- [5] L. Abou-Khalil et al., *Acta Materialia*, 110 (2016) 44–52.
- [6] A.G. Murphy et al., *J. Cryst. Growth* 454 (2016) 96–104.

## The future of the ICAPS programme

Blum J.<sup>1\*</sup>,  
<sup>1</sup>IGeP, TU Braunschweig, Germany

Following the 1998 Announcement of Opportunity of ESA for the utilisation of the ISS, the Interactions in Cosmic and Atmospheric Particle Systems (ICAPS) programme was proposed by an international team in 1999 and was rated "outstanding" by the reviewers. After various studies, the ICAPS programme was finally cancelled by ESA in 2015 due to budgetary constraints. To rescue some of the science, a follow-up sounding-rocket experiment has recently been recommended by the Physical Science Working Group (PSWG) of ESA.

The ICAPS science team, comprising scientists from Germany, Belgium, France, Spain, the UK, Finland, Canada, the USA and Russia plans to study the growth of dust agglomerates in nascent solar systems from micrometre-sized solid grains to millimetre-sized fractal clusters [1]. In a first step and after creating a homogeneous cloud of single monomer SiO<sub>2</sub> grains dispersed in N<sub>2</sub> gas of about 1 mbar pressure, the particles will be subjected to Brownian motion only. Hence, they will collide at extremely low velocities and form large fractal agglomerates. Such experiments are only feasible in a long-duration microgravity environment. To avoid loss of particles due to diffusion, thermophoretic cloud motion or other external disturbances, the dust cloud will be spatially confined using a novel

cloud manipulation system (CMS). In a second step, the CMS will be used to "squeeze" the dust cloud into smaller and smaller volumes, thereby initiating collisions among the fractal aggregates at higher velocities so that compaction of the dust clumps is expected, a process that is believed to also occur in planet-forming regions. At the end of this process, most of the initial dust grains will be within a few large aggregates. The image sequence in Fig. 1 shows agglomerate growth observed in a short-duration drop-tower experiment utilising the CMS.

During the whole growth process from single grains to macroscopic agglomerates, the dust particles will be observed by a long-distance microscope (LDM) with attached high-speed camera and by a light-scattering unit (LSU). While the former shall deliver data about the morphology and size distribution of the forming dust clusters, the latter will allow to measure the intensity and polarisation of light (in three wavelengths) scattered in arbitrary directions. These measurements are of utmost importance for the interpretation of astronomical observations of so-called protoplanetary discs in which dust grows into planetary bodies. Also here, the CMS plays an important role as it allows to place individual dust aggregates into the field of view of the LDM and LSU. Such an agglomerate "scanning" process is illustrated in Fig. 2. Active experiments on the behaviour of individual dust clusters under the influence of light (photophoresis) are also planned.

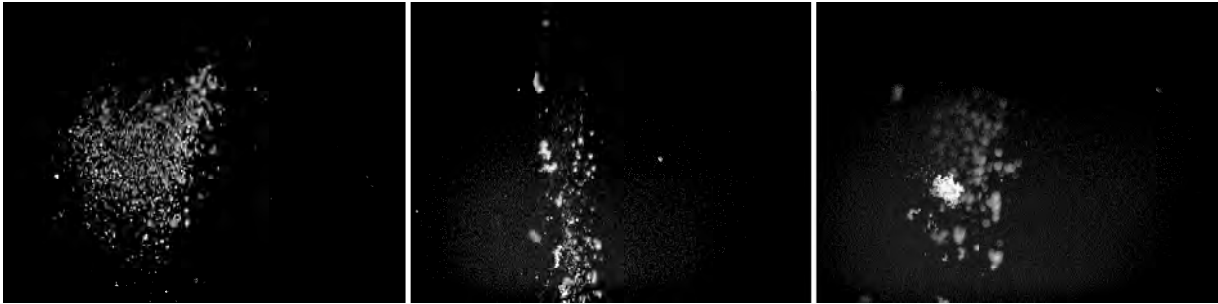

Figure 3: Growth of agglomerates during cloud squeezing by CMS. The horizontal image size is 10 mm with 0.5 s between the frames .

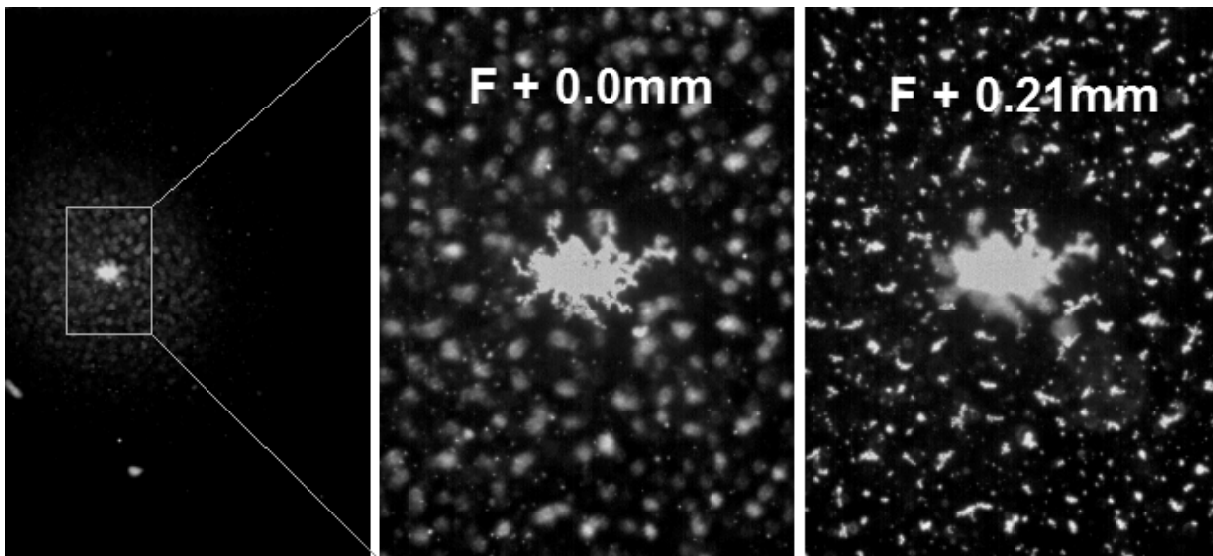

Figure 2: Agglomerates being delivered to the focal plane of the observation camera and being scanned through the camera's field of view. The horizontal size is 8.6 on the first and 1.8 mm on the last two images.

### References

[1] J. Blum, A.-C. Levasseur-Regourd, O. Muñoz, R. J. Slobodrian, A. Vedernikov, Dust in space, *Europhysics News* 39(3) (2008) 27-29.

### VIPIL-FARADAY: Vibrating Fluids- Instability and Patterns

Shevstova V.<sup>1\*</sup>, Zoueshtiagh F.<sup>2</sup> Narayanan R.<sup>3</sup>,  
<sup>1</sup>MRC, CP-165/62, Free university of Brussels (ULB), Brussels, Belgium,  
<sup>2</sup>(IEMN) UMR CNRS, 8520, Avenue Poincare, Villeneuve d'Ascq 59652, France,  
<sup>3</sup>Dept. Chem. Eng., University of Florida, Gainesville, Florida 32611, USA

VIPIL-Faraday or vibrating interfaces with inter-diffusing liquids represents a significant fluid mechanics ground and microgravity

program involving a collaborative team from Belgium, France, India, Russia, Japan and the United States. The main goal of this investigation is to study, characterize, and predict the experimental fluid patterns arising from parametric forcing in microgravity and compare the patterns with ground experiments. The patterns are a result of fluid instability which is connected to resonant interactions between periodic mechanical forcing and the natural frequency of a system.

The VIPIL- Faraday team is principally involved with two types of experiments- one where the forcing is in a direction normal to the common interface and another where it is roughly parallel to it. The fluid system is a pair of equivalent volume of FC-72 and 1.0

cSt Silicone that becomes progressively miscible as the temperature rises from 25°C toward the consolutal temperature of around 42.5°C. The team has identified the need for microgravity as follows.

A) Gravity level plays a dual but contradictory role according to the theoretical predictions. This is quite unexpected and low gravity experiments are badly needed to examine the veracity of this result. Moreover, the theory indicates that mode delineation will become impossible at low gravity and high forcing frequency. This lack of pattern delineation is of great scientific and technology application interest and its very occurrence must be investigated to verify if and why the predictions are valid.

B) Under earth's gravity the role of interfacial tension is insignificant. The effect of this force can best be studied in microgravity conditions or under extremely small geometries on earth. However very small geometries will cause severe wall damping and obliterate the phenomenon that is due to Faraday resonance. In other words, it is only under microgravity that we can really extract the phenomenon of Faraday resonance in such a way that interfacial forces influence the natural frequency and not just the body force of gravity.

C) When the fluids are miscible, interfacial tension is absent and so the stabilization of patterns must necessarily be due to diffusion. However, gravity comes into play on earth and generates natural convection with wavelengths of the order of the expected

patterns. In order to understand Faraday type resonance with miscible fluids and avoid natural convection we must have microgravity.

At the time of this publication, the VIPIL-Faraday team has very successfully performed ground experiments and verified the observations with predictions (Fig. 1). We have also performed a series of Parabolic flight experiments in order to see if the experiment may be conducted under low gravity (Fig. 2). The figures compare the vibrational patterns seen when the forcing is done parallel and normal to the interface under earth's gravity and under microgravity. Parabolic flight experiments have yielded fruitful results insofar that nearly flat interfaces may be achieved with acoustic control when the fluids are immiscible. However, the microgravity time of Parabolic flights are very limited, residual gravity is not negligible, and consequently very inadequate. Based on concrete scientific experimental evidence and theories we are convinced that long-term microgravity experimentation with a better quality of microgravity environment is needed to examine the behavior of resonance with both immiscible and miscible fluid interfaces.

The technological applications of this work are far-reaching. They involve, principally microfluidic mixing, small drop removal for food safety, pharmaceutical production in slug flow micro channels, and even virus detectors in small diameter oscillatory flow configurations. Additionally in space applications, the various instability patterns may assist as an anti-sloshing mechanism and even in drop and bubble management in two phase processing.

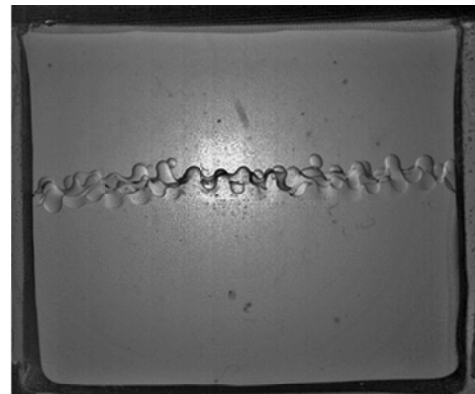
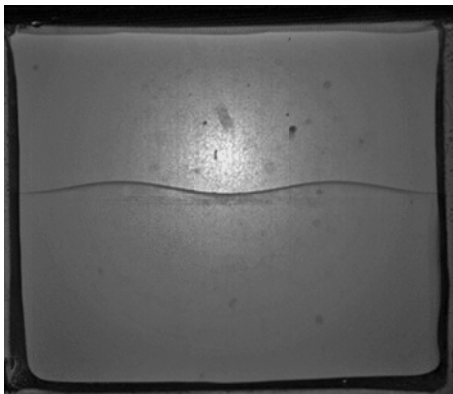

Figure 1: Faraday instability between FC-72 and 1.0 cSt Silicone oil at 40°C, just below the consolutal temperature of 42.5°C. The vibrations are perpendicular to initially horizontal interface at  $f=7\text{Hz}$ ,  $A=2.5\text{mm}$ . (left: on ground; right: in microgravity)

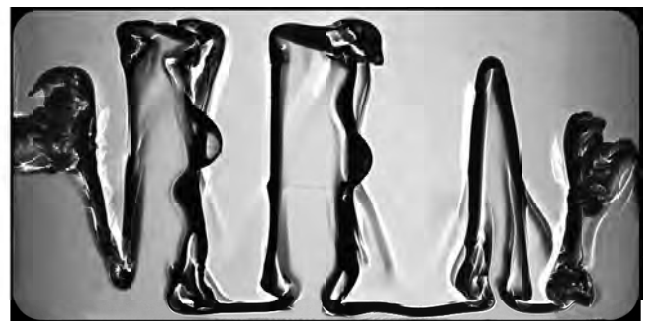

Figure 2: Interfacial patterns in miscible liquids under vibrations parallel to initially horizontal interface at  $f=8\text{Hz}$ ,  $A=10.7\text{mm}$ . (left: on ground; right: in microgravity)



## RITMI – Tissue Repair in Microgravity

Monici M.<sup>1\*</sup>,

<sup>1</sup>ASAcampus JL, ASA Res. Div.-Univ of Florence, Florence, Italy

Wound healing is crucial for the survival of an organism. Therefore, in the perspective of space exploration missions, it is important to understand if and how microgravity ( $\mu g$ ) conditions affect the behavior of the cell populations involved in wound healing and the evolution of the process.

Wound healing in  $\mu g$  is to date relatively unknown, but functional alterations induced by unloading conditions have been observed in "in vitro" [1],[2] and "in vivo" models. Studies in animals have produced ambiguous results, even if the prevailing evidence indicates an impairment of the healing process [3]-[7].

The scientific project RITMI – Tissue Repair in Microgravity (Riparazione dei Tessuti in Microgravità), coordinated by Monica Monici and founded by ASI – The Italian Space Agency (ASI N. 2013-090-R.O) – was aimed at investigating the effects of  $\mu g$  on the molecular and cellular mechanisms of wound healing, by using "in vitro" and "in vivo" models. Moreover, one of the objectives of the project was the development of possible countermeasures to promote healing in low gravity conditions and also on Earth.

The 3 years program started in March 2014 and involved 3 research units: University of Florence (Dr. M. Monici and Prof. P. Cirri), University of Siena (Prof. L. Morbidelli) and University of Milano (Prof. F. Celotti).

Due to the central role that fibroblasts play in the repair process, most of the studies were done on these cells, utilizing the murine cell line NIH-3T3 and the human cell line NHDF as models. The results achieved show that 72h exposure to  $\mu g$ , modeled in a rotating cell culture system (RCCS), affects proliferation and migration, causes cytoskeletal alterations (a rearrangement of microtubules occurred and the bundles of  $\alpha$ -SMA, a marker of fibroblast-myofibroblast transdifferentiation, were replaced by a tight network of faulty and disorganized filaments), induces a decreased expression of E-CAD (an adhesion target), and CD-40, a member of the TNF receptor family and receptor for the adhesion of mononuclear cells.

In details, in samples exposed to modeled  $\mu g$ , the number of cells able to adhere to the substrate decreased by 27 %, compared to controls (1xg).

The ability of fibroblasts to migrate, assessed by means of multiple testing (scratch assay, Boyden chamber assay, measure of the cells migrating from beads to a plate surface) was significantly impaired after exposure to unloading conditions. Also the ability to migrate in response to an effective chemoattractant (platelet rich plasma, PRP) closely related to cytoskeleton integrity and membrane junctions, was significantly impaired. Nevertheless, PRP addition to cell cultures was able to partially restore fibroblast migration.

Moreover, the exposure to modeled  $\mu g$  increased COX-2 production and the expression of other inflammatory markers such as iNOS, the inducible isoform of nitric oxide synthase, and prostaglandin E2. Contrariwise, the expression of proangiogenic proteins (VEGF e FGF-2) decreased.

It is worth of note that the exposure to modeled  $\mu g$  for shorter time intervals does not affect NIH-3T3 cell proliferation while inhibits the migration and adhesion efficiency of the cells. Conditioned media from fibroblast cultures exposed to modeled  $\mu g$  produce a slower migration and reduced formation of tube-like structures by endothelial cells (HUVEC cells) in 3D Matrigel matrix culture, as compared to the effects produced by media of fibroblasts kept at 1xg. Similar results have been obtained in co-cultures of fibroblasts and HUVEC cells. These results show that  $\mu g$  might exert important influence on the pro-angiogenic effects produced by fibroblasts, which are essential in wound repair.

The effects of  $\mu g$  have been studied also on Keratinocytes, cells of major relevance in cutaneous wound healing. These cells show a consistent impairment in their ability to adhere to the substrate and form monolayers after exposure to reduced gravity. The addition of PRP to these cultures enhances their proliferation but not their adhesion properties.

As possible countermeasure to  $\mu g$ -induced alterations, beside the addition of PRP to the models used, we have also utilized a physical approach, applying laser radiations and electromagnetic fields. NIR laser (3, J/cm<sup>2</sup>) and electromagnetic fields (16,2 G – 50 Hz ) seem to improve fibroblast migration in a scratch assay test. Also in an "in vivo" model of suture healing (*Hirudo medicinalis*), NIR laser radiation has proved its efficacy in promoting tissue repair.

In conclusion, our studies have shown that modeled  $\mu g$  significantly and affect the fibroblast behavior, inhibiting important basic cellular functions, essential in the process of wound healing [8]. The models utilized in these studies might represent a useful tool to investigate effective physical and chemical countermeasures able to improve healing in low gravity conditions.

### Acknowledgements

This study was funded by the Italian Space Agency (Tissue Repair in Microgravity ASI N. 2013-090-R.O)

### References

- [1] Monici M, Cialdai F, Romano G, Fusi F, Egli M, Pezzatini S, Morbidelli L. An in vitro study on tissue repair: impact of unloading on cells involved in the remodelling phase. *Microgravity Sci. Technol.*, vol. 23, p. 391-401, 2011. ISSN: 0938-0108, doi: 10.1007/s12217-011-9259-4
- [2] Cialdai F, Monici M. Wound healing: what happens in microgravity?. *Current Biotechnology*, vol.2, p. 250-256, 2013. ISSN: 2211-5501, doi: 10.2174/22115501113026660025
- [3] Campbell MR, Kirkpatrick AW, Billica RD, et al. Endoscopic surgery in weightlessness: the investigation of basic principles for surgery in space. *Surg. Endoscopic.*, 2001, 15: 1413-8.
- [4] Campbell MR, Williams DR, Buckey JC Jr, Kirkpatrick AW. Animal surgery during spaceflight on the Neurolab Shuttle mission. *Aviat Space Environ Med.*, 2005, Jun;76(6):58993.
- [5] Davidson J, Aquino A, Woodward S, et al. Sustained microgravity reduces intrinsic wound healing and growth factor responses in the rat. *FASEB J.*, 1999, 13(2):325-9.

[6] Midura RJ, Su X, Androjna C. A simulated weightlessness state diminishes cortical bone healing responses. *J Musculoskelet Neuronal Interact.*, 2006, Oct-Dec;6(4):327-8.

[7] Heinemeier KM, Olesen JL, Haddad F, Schjerling P, Baldwin KM, Kjaer M. Effect of unloading followed by reloading on expression of collagen and related growth factors in rat tendon and

muscle. *J Appl Physiol.*, 2009, Jan;106(1):178-86. Epub 2008 Nov 6.

[8] Cialdai F, Vignali L, Morbidelli L, Colciago A, Celotti F, Santi A, Caselli A, Cirri P, Monici M, *Microgravity Sci. Technol.*, 2017, doi:10.1007/s12217-016-9532-7

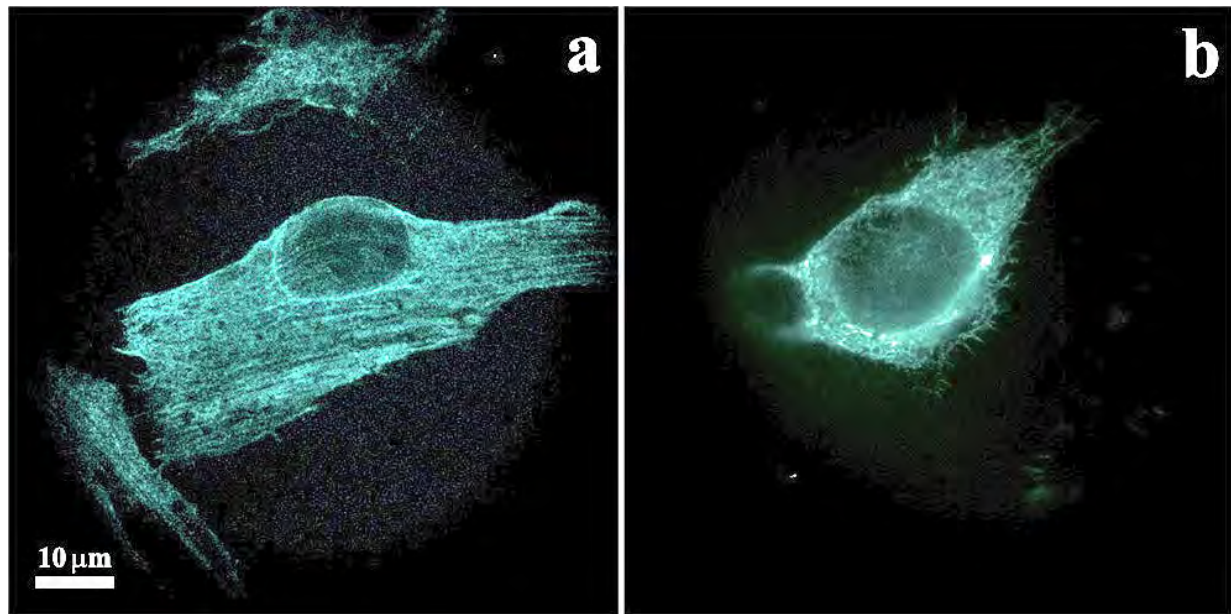

Figure 1: Fluorescence microscopy:  $\alpha$ -SMA expression and organization in fibroblasts – a) control cells (1xg) show parallel bundles of  $\alpha$ -Smooth Muscle Actin ( $\alpha$ -SMA), a marker of fibroblast-myofibroblast transdifferentiation. b) in fibroblasts exposed for 72h to unloading conditions the  $\alpha$ -SMA bundles were replaced by a tight network of faulty and disorganized filaments.

### Why does Bacteria Behave differently in Space?

Zea L.<sup>1\*</sup>,

<sup>1</sup>Universidad del Valle de Guatemala, Guatemala City, Guatemala

At the dawn of the American and Soviet space programs it had been calculated that bacteria were too small to be affected by the reduced-gravity environment of spaceflight [1]. However, as microbial research began in earnest on the Salyuts and Skylab space stations and was followed during Space Shuttle flights, something different was observed. Research showed – especially on liquid cultures – enhanced bacterial proliferation, increased virulence or capacity to cause disease, a thicker cellular envelope, decreased susceptibility to antibiotics, and accelerated genetic recombination via conjugation [2]. Experiments on the International Space Station (ISS) have not only replicated some of these observations on a more systematic fashion, but also shown new altered behavioral patterns, like modified and improved biofilm formation [3]. With no one disproving the calculations from the 1960's, which mathematically showed bacteria were too small to be affected by microgravity, the

biophysical mechanism governing these altered behavioral patterns remained elusive. In the 1980's it was hypothesized that the lack of convection in space could impair nutrient uptake with respect to 1g [4]. This idea was further developed into an altered mass transport theory under the premise that in microgravity, molecule transport to and from the cell is limited to diffusion, forming a quasi-stable boundary layer around the bacterium composed of increased metabolic byproducts and reduced substrate concentrations as they are consumed by the organism [5]. However, during decades this theory could not be either proven or disproven by empirical or computational means [6,7].

With the objective of testing the altered extracellular environment theory, a bacterial experiment was recently performed on board the ISS (Fig. 1) [8]. *E. coli* cultures were grown in liquid medium in space and their gene expression was compared against that of matching Earth controls. This transcriptomic analysis showed that bacteria in space were experiencing starvation conditions, although they had the same amount of substrates as the Earth controls. It also indicated that cells were exposed to an acidic environment, although the pH of the bulk fluid was the

same in space and Earth – suggesting that the increased acidity was limited to the zone surrounding the individual cells. These two results were corroborated through at least three independent molecular genetic pathways, each. This gene expression data supports the altered extracellular environment theory for the first time, and resulted in the development of the biomolecular model presented in Fig. 2 and recently published in [8]. The elucidation of the biophysical processes explaining the mechanical transduction signals that cells experience in space may provide insight into the altered bacterial behavior observed since the times of the Salyut and Skylab space stations, and may help us better prepare for infectious disease outbreaks in astronauts venturing into deep space.



Figure 1: NASA Astronaut Mike Hopkins operating the bacterial experiment onboard ISS that helped elucidate the biophysical processes explaining the altered extracellular environment in space (Photo credit: NASA).

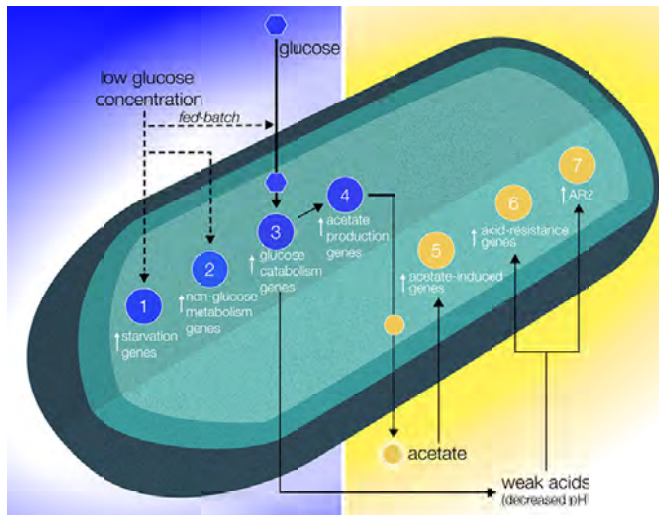

Figure 2: Representation of a biophysical model explaining the altered extracellular environment in space. In microgravity, a quasi-stable substrate-poor and metabolic byproduct-rich boundary layer may form around the cell. Image from [8].

Further transcriptomic, genomic and phenotypic data from this experiment is still to be analyzed under a true international spirit, with collaborator from the U.S. (University of Colorado, Boulder and HudsonAlpha), Germany (German Aerospace Center, DLR), Denmark (University of Copenhagen), and Brazil (The Pontifical Catholic University of Rio Grande do Sul).

## References

- [1] Pollard, E. C. (1965). Theoretical studies on living systems in the absence of mechanical stress. *Journal of theoretical biology*, 8(1), 113-123
- [2] Horneck, G., Klaus, D. M., & Mancinelli, R. L. (2010). Space microbiology. *Microbio. Molec. Bio. Rev.* 74, 121-156
- [3] Kim, W., Tengra, F. K., Young, Z., Shong, J., Marchand, N., Chan, H. K., Pangule, R. C., Parra, M., Dordick, J. S., Plawsky, J. L. & Collins, C. H. (2013). Spaceflight promotes biofilm formation by *Pseudomonas aeruginosa*. *PLoS one*, 8(4), e62437
- [4] Bjorkman, T. (1988). How to detect when cells in space perceive gravity. NASA Conference Publication 100034. Retrieved from: <http://ntrs.nasa.gov/archive/nasa/casi.ntrs.nasa.gov/19900004623.pdf>, page=122
- [5] Klaus, D., Simske, S., Todd, P., & Stodieck, L. (1997). Investigation of space flight effects on *Escherichia coli* and a proposed model of underlying physical mechanisms. *Microbiology*, 143(2), 449-455
- [6] Benoit, M.R., Brown, R. B., Todd, P., Nelson, E. S., & Klaus, D. M. (2008). Buoyant plumes from solute gradients generated by non-motile *Escherichia coli*. *Phys. Bio.* 5, 046007
- [7] Owen, R. B., Zozulya, A. A., Benoit, M. R., & Klaus, D. M. (2002). Microgravity materials and life sciences research applications of digital holography. *App. Optics* 41, 3927-3935
- [8] Zea, L., Prasad, N., Levy, S. E., Stodieck, L., Jones, A., Shrestha, S., & Klaus, D. (2016). A Molecular Genetic Basis Explaining Altered Bacterial Behavior in Space. *PLoS one*, 11(11), e0164359.



### Magnetic field effects on the growth of bacterial populations

Ponomarenko A.<sup>1\*</sup>, Gaudeau de Gerlicz C.<sup>2</sup>, d'Herouville X.<sup>2</sup>, Pushkina V.<sup>3</sup>, Godlevsky L.<sup>1</sup>,  
<sup>1</sup>Odessa National Medical University, Odessa, Ukraine,  
<sup>2</sup>Bioespas International laboratory Tours, France,  
<sup>3</sup>Ukrainian I.I. Mechnikov Anti-Plague Research Institute, Odessa, Ukraine

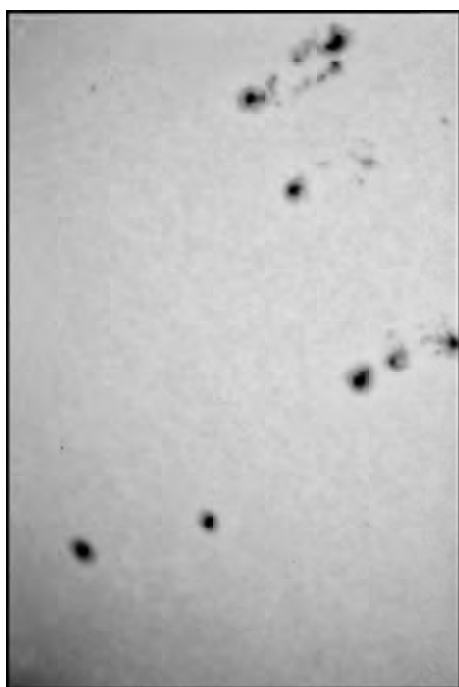

Figure 1: Sunspots (April 2014).

In a previous newsletter we have pointed at the hypothesis of a close relationship between variations of the "Space Weather" (especially solar activity particles) and occurrence and development of past epidemics.

At the beginning of 2014, there was a very strong solar activity. The source of this activity is the AR1944 sunspot, one of the biggest spots observed in the last ten years. The monstrous sunspot AR1944 located directly facing the ground was very active with energy for strong solar flares. The sprawling active area was over 200000 km wide and contained dozens of dark nuclei. On January 7, a class X 1 explosion of the sunspot launched a CME in the direction of the earth. NOAA forecasters estimated the risk of strong geomagnetic storms at 60%. This continuous radiation storm was S2 class on the NOAA scale, potentially causing electronic devices to fail and influencing the health of the Earth's inhabitants.

On april 2014, sunspots number was still approximately 12 (Fig. 1) and solar wind pressure was 20 (nPa) (Fig. 2)

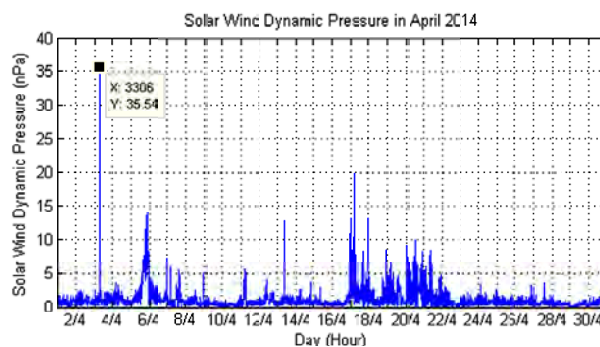

Figure 2: Solar wind pressure (April 2014).

The year 2014 was also the year of the epidemic of the Ebola virus in West Africa, with a peak of morbidity and mortality observed between September and December 2014 (Fig. 3), i.e., 9 to 12 months after the exceptional peak of activity of the solar spot AR1944.

Based on these hypothesis, growing impact of the anthropogenic magnetic fields (MF) on Biosphere and approaching of the geomagnetic field reversal with concomitant geomagnetic distortions requires urgent analysis of possible consequences.

It is widely accepted that bacterial infections secondary to viral epidemics complicate the life prognosis of patients and therefore have a direct impact on the mortality rate of the viral epidemic process.

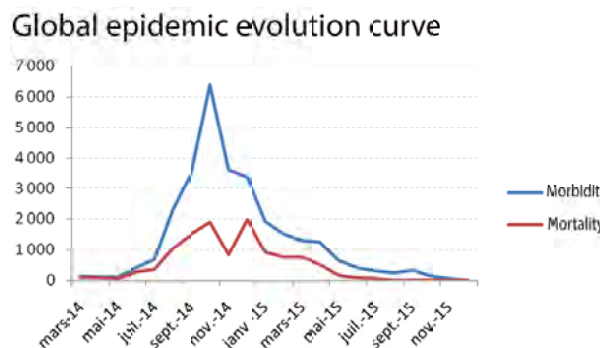

Figure 3: Evolution of cumulative mortality during the Ebola epidemic in West Africa in 2014.

We evaluated effect of weak, extremely low frequency MF (WELFMF) on bacterial growth. Seven freshly isolated from patients strains of Staphylococcus aureus and Pseudomonas aeruginosa, as well as laboratory strain of Escherichia coli were studied.

Statistically significant stimulation of the bacterial growth by WELFMF (50- 200 μT, 2 Hz) under normal day light / night darkness cycling conditions was shown: bacterial colonies count increased up to 8 times and their diameter increased up to 3 times (p < 0.02).

These results correlate with our idea that proteins of Cryptochrome/photolyase family represent the universal magneto-sensor inside cell genome[1]. Thanks to this biological "antennae" both: bacterial and eukaryotic cell genomes are able to respond to mag-

netic signals. It is known that in bacteria photolyases function as DNA repair enzymes. Obtained results suggest that the WELFMF can activate functional activity of these proteins, activate DNA repair and, consequently, stimulate bacterial growth.

**Conclusion:** Bacterial growth stimulation by WELFMF under normal light/darkness cycling conditions was shown. This finding is important for occupational hygiene, epidemiological service and microbiological experiments design.

© SOLAR SUNSPOTS view (17/04/2014): etx 90mm meade

canon eos 600d, obj 50mm, telecommand canon, infrared filter ir720nm, 1/4000, shooting 10h30 AM weather clean, NW orientated, from Hugues Richard DELYS photographer

#### References

[1] Zaporozhan, Ponomarenko (2010). Mechanisms of Geomagnetic Field Influence on Gene Expression Using Influenza as a Model System: Basics of Physical Epidemiology. *Int J Environ Res Public Health*, 7(3), 938-965.

### Articles Welcome

Many thanks to all contributors of this issue of the ELGRA NewsLetter!

Please note that all ELGRA members are invited and encouraged to submit material including meeting announcements and reviews, reports or summaries, books announcement and reviews, brief research highlights, member news and editorials. Please send your contributions to the ELGRA Publications Editor (see cover page).

## An experiment in zero gravity with the question: What is the impact of microgravity on the height of a cell?

Eckert J.<sup>1\*</sup>,

<sup>1</sup>VU - University Amsterdam, The Netherlands



### The Bio-X Experiment

The Bio-X Experiment under the direction of J. J. W. A. van Loon is a collaboration between VU Medical Center Amsterdam, ESA-ESTEC TEC-MMG and TEC-MXE. It is an experiment to study the change of cell height under different gravitational levels. This experiment is based on a hypergravity atomic force microscope experiment [1], which studied the change of cell shape at hypergravity up to 3 g. It was found that in this gravitational range the average height of a single cell reduces by around 30-50 %.

In the Bio-X Experiment, the aim is not only to measure the gravitational impact of more than 1 g on cell height, which can be simulated in a centrifuge. The focus is also in the microgravity range. In this case, the experiment is performed in a parabolic flight.

This article will focus on the preparation of the samples.

### Preparation of samples

For this parabolic flight campaign the samples, ABSA15 seabream and SSJ1 salmon (fish cell lines, a gift from Prof Cancela from the BIOSKEL group at the Center of Martine Sciences, Portugal), are prepared at ESA/ESTEC in the Netherlands. The time between the preparation and the use for samples at the parabolic flight is one week. It is needed to identify a way to have the cells with a perfect density at the flight days. It means the cells should not too few for too limited statistics and not too much so they do not form clusters and overlaps. This is the second point. Cells with an overlap can probably influence each other. Single cells are preferred.

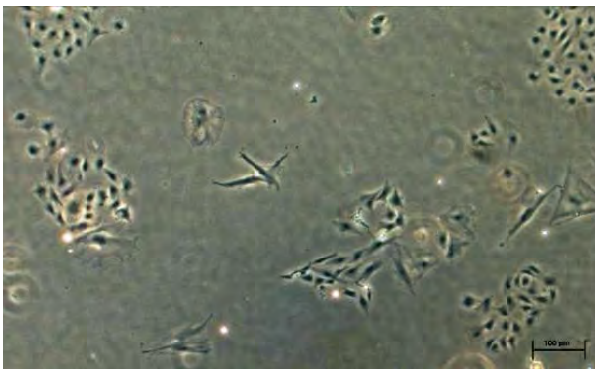

Figure 1: Clustering of fish cell line ABSA15 seabream after 8 days of cultivation.

To prepare the samples cells are seeded in sterilized  $\mu$ -Slides ( $\mu$ -Slide I, Ibdidi). To do that and for cell cultivation, a culture medium is used. This medium is composed of serum, penicillin, streptomycin, fungizone, L-glutamine and Leibovitz L-15 medium. For the above conditions, serum is the key for the preparation of cells, because it is responsible for the cell growth.

The amount of serum in a culture medium is 10 %. Tests with different concentrations of cells show, that for lower concentrations the cells are growing slower. It can be seen that these cell types prefer clustering, see Figure 1. In another test it was found that the speed of growth depends on the amount of serum. With concentrations less than 1 % of serum, the cell growth is extremely slow. The solution for the preparation of samples is to have a high cell density and single cells without overlaps.

The rationale of preparation of samples for the parabolic flight consists of few steps. The first step is using a high concentration of cells and growing the cells in 10 % serum. Secondly before the cells touch each other, the cell growth must be arrested using lower concentration of serum.

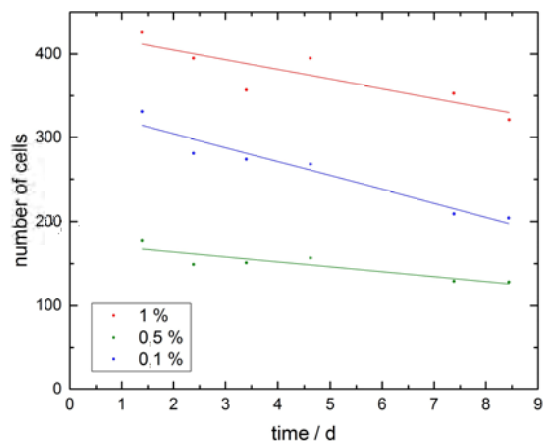

Figure 2: The number of SSJ1 salmon cells during 8 days after arresting. After 14,5 h reduce cell proliferation with low concentration of serum (1 %, 0,5 % and 0,1 %).

Figure 2 shows the number of salmon cells for 8 days after reducing their growth. Therefore, after 14,5 h of cultivation of 10 % serum media with different low amount of serum are used to arrest the cell proliferation. It is shown that for salmon cells the best amount of serum to nearly arrest the cell growth is 0,5 %. For seabream cells it is 0,1 % of serum (data not shown).

### ESA parabolic flight campaign

To measure the cell height, a lensless microscope is used, for more details see [2]. In the setup of the Bio-X Experiment there are two microscopes, one for each fish cell type, see Fig. 3.

During the parabolic flight campaign three flights are provided. Per flight 31 parabolas are flown including 5 breaks. During the experiment the sample is changed once per flight. In the other breaks the field of view is changed. This means, that 18  $\mu$ -Slides, including backup, have to be prepared.



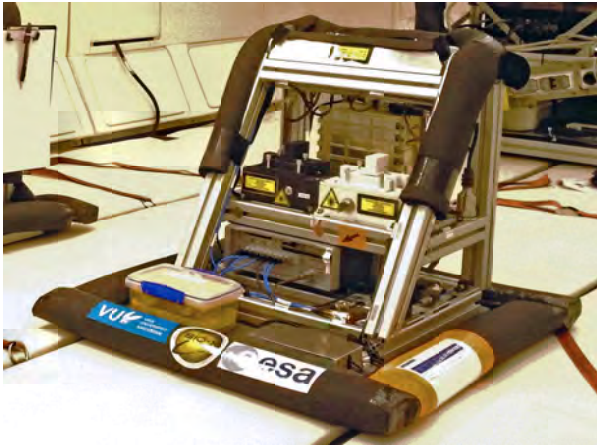

Figure 3: Bio-X Experiment, two lensless microscopes (black and white) and a box with samples.

A total of 40  $\mu$ -Slides are prepared for the experiment, see Fig. 4. For this purpose, the above-mentioned serum amounts are used. Here, samples are prepared with using different types of serum for arresting of cell proliferation. The reason is to see, if the serum type has an influence on the flexibility of cells and therefore on changes of their height.



Figure 4: 40  $\mu$ -Slide samples used for the parabolic flight.

The evening before each flight, 6 samples with the highest con-

centration of cells, but not overlapping each other, are chosen. In the morning before the flight the first two samples are placed in the microscopes on board the aircraft. After takeoff the task is to turn on all devices. The microscopes shall be switched on and the measurement could be started. During the flight, the data acquisition needs to be monitored.

Finally, now the data have to be analyzed.

These activities associated with the Bio-X Experiment were based on my internship at ESA-ESTEC HSO. Jack van Loon gave me the opportunity to work on this project and I want to say thank you to him.

Also, I want to thank ELGRA for their support and for giving me the chance to participate in the implementation of the Bio-X Experiment during the parabolic flight. It was a great experience for me. I will never forget this adventure!



Thank you very much ELGRA for your support!

### References

- [1] Van Loon, J. J. W. A., Van Laar, M. C., Korterik, J. P., Segerink, F. B., Wubbels, R. J., De Jong, H. A. A. & Van Hulst, N. F. "An atomic microscope operating at hypergravity for in situ measurement of cellular mechano- response", *Journal of Microscopy*, Vol. 233, Pt. 2, pp. 234 - 243, 2009.
- [2] Noom, D. W. E., Eikema, K. S. E. & Witte, S. "Lensless phase contrast microscopy based on multiwavelength Fresnel diffraction", *Optics Letters*, Vol. 39, No. 2, pp. 193 - 196, 2014.

### Amazing plasma under varying gravity

Sperka J.<sup>1\*</sup>,

<sup>1</sup>Masaryk University, Faculty of Science, Department of Physical Electronics, CZ-61137 Brno, Czech Republic

Human beings always admired fascinating natural phenomena such as daily sunrise and sunset on the sky, rainbows or unique auroras. Aurora, known also as polar light, is a structure on the night sky formed of ionized and excited air particles, which can emit photons of various colours visible also to human naked eye. It is example of matter called plasma. Another, much more common example of nat-

ural plasma is the tropospheric lightning that occurs during thunder storms. Unlike wide, diffusive aurora, it is much less spatially expanded and it manifests itself in the form of very bright channels of relatively small diameter in the atmosphere. Though lightning is accompanied breath-taking sound and bright light. Not so well known type of lightning can occur above clouds. This lightning has diffusive character due to lower pressure and it is clearly distinguishable from aurora. This, so called upper-atmospheric lightning, called also 'transient luminous event', is of different types and is well observable from orbit. Very nice color pictures of this phenomenon were obtained during observations by ISS astronauts. Laboratory

counterparts of these discharges in the Earth's atmosphere are under investigation of plasma scientists for many years. One example that demonstrates the similarities between natural and laboratory plasma is experiment of the Norwegian scientist Kristian Birkeland, who used magnetized model ball in vacuum representing the Earth to simulate aurora. In the laboratory, plasma discharges are often used to initiate chemical reactions, as was also done during the famous Miller-Urey experiment that intends to simulate conditions on the early Earth.



Pplasma under varying gravity.

Laboratory plasmas can be used for more than just to simulate natural phenomena. They also have many practical applications in various areas such as semiconductor industry, material processing or aerospace engineering. Atmospheric pressure plasmas are quite easy to be ignited (e.g. electrostatic spark discharge) and one of the first to be systematically investigated was the electric arc discharge. It is characteristic for its contracted hot plasma channel that has typical upward bow shape due to buoyancy acting on hot gas. For our investigations under varying gravity conditions, we chose a similar type of plasma – so called gliding arc plasma. It differs from the stable arc mainly in the electrodes geometry, which enables buoyancy and/or gas flow induced periodic movement of the plasma channel. The gliding arc discharge is formed at the smallest gap in-between diverging electrodes. The plasma channel then propagates as it glides along the electrodes until it dissipates when the channel reaches its maximum length. The plasma properties can change drastically during such glide. In our case, plasma characteristics of the gliding arc discharge were close to so called atmospheric pressure glow discharge.

The ESA education Spin Your Thesis! (SYT) programme allowed us to perform several diverse hypergravity experiments (up to 18 g) with this plasma discharge in the Large Diameter Centrifuge (LDC) at ESA-ESTEC in Noordwijk, the Netherlands. Our student team from Masaryk University (MU) Brno got the opportunity to perform experiments during two SYT programmes – SYT2012 (name of the project : 'Gliding arc under varying hypergravity: plasma diagnostics and deposition of carbon nanostructures', team GRAVARC – GRAVity ARC: two student team members – Pavel Souek and myself, endorsing professor Vit Kudrle from MU and ELGRA mentor G.M.W.Kroesen from Eindhoven University of Tech-

nology) and SYT2013 (name of the project: 'Plasma diagnostics of gliding arc under varying hypergravity', team GRAVARC TNG; three student team members: Lucia Potocnakova , Petr Zikan and myself). Gliding arc was operated in buoyancy driven regime (i.e. with very low external gas flow). Therefore we expected to observe that plasma behaviour depends on gravity. At the end, the results exceeded our hopes. We studied the effects of gravity on the movement, shape and emission spectra of the discharge. The preparation and installation of our experimental setup into LDC gondola was performed with great help of professionals from ESA. We had many measuring instruments and we experienced several unexpected moments, for example when oscilloscope in gondola exhibited problems with relay at higher gravity levels, which was simply solved by placing the oscilloscope on its back. During SYT2012 we studied the gliding arc in pure helium and in a methane-rich atmosphere, which allowed us to produce solid state carbon products due to the plasma-chemical reactions involved. The influence of gravity on gliding arc plasma was unambiguously proven during SYT2012.



Research team.

The second year, many parts of the GRAVARC experimental setup had been changed or improved. The main goal of SYT2013 project was to better understand the processes that govern the glide arc plasma in different noble gases (helium, neon, argon, krypton) under varying gravity conditions. I have to say that I personally consider ESA education SYT programme to be a perfect opportunity for students to get new experiences, meet interesting people and learn really a lot in an international European setting. At the end of this text I would like to thank all the people that supported us during our work on GRAVARC experiment, especially Jack J.W.A. Van Loon. The experiments at LDC are over, however, the research on GRAVARC continues. We still evaluate some data from LDC and during this summer we performed exciting experiments with gliding arc plasma in wind tunnel at gas flow rates up to 45 m/s which will bring us new interesting information about gliding arc behaviour under extreme conditions.

For more information see

[http://m.esa.int/Education/Spin\\_You\\_Thesis/Meet\\_the\\_teams\\_GRAVARC](http://m.esa.int/Education/Spin_You_Thesis/Meet_the_teams_GRAVARC)

[http://m.esa.int/Education/Spin\\_Your\\_Thesis/Meet\\_the\\_teams\\_GRAVARC\\_TNG](http://m.esa.int/Education/Spin_Your_Thesis/Meet_the_teams_GRAVARC_TNG)

### A live chat with an astronaut

PhD student Julia Attias, has taken part in a live chat with British astronaut Tim Peake, as part of "I'm An Astronaut, Get Me Out Of Here!", a free activity that lets school students meet and interact online with the team behind a human space mission.

The chat, which took place on 4 November, gave schoolchildren the chance to speak to and learn from Tim Peake, as well as Julia who won the chance to take part through her role as an Astro Support Team member for "I'm An Astronaut, Get Me Out Of Here!".

The programme was split into four stages (known as "zones"), which all lasted two weeks. In each stage of the competition five Astro Support Team members answered students' questions and the schoolchildren then voted for their favourite member from each round. Julia, who is studying for a PhD in Space Physiology, Centre of Human & Aerospace Physiological Sciences, was voted winner of the Launch Zone round.

In Friday's live chat, Julia along with Tim and the other three Astro Support Team winners, faced questions from selected schoolchildren.

Julia is currently researching ways that will help to protect astronauts' bodies in space and to aid her research she works with a SkinSuit that has been designed to recreate gravity. Julia is particularly interested in how the Skinsuit interacts with exercise, and any changes it may incur to the cardiorespiratory and neuromuscular systems. The Skinsuit, a collaboration with MIT and European Space Agency, has already been sent to the International

Space Station once in September 2015, and Julia's research will be important for any future space missions.





Leguy C.<sup>1\*</sup>, González-Cinca R.<sup>2</sup>, Lockowandt Ch.<sup>3</sup>,

<sup>1</sup>Division Space Physiology, German Aerospace Institute, Linder Hoehe 1, D-51147 Cologne, Germany,

<sup>2</sup>Department of Applied Physics Universitat Politècnica de Catalunya-BarcelonaTech Ed. C3, c/ E. Terradas, 5, 08860 Castelldefels (Barcelona), Spain,

<sup>3</sup>Science Services Division, Swedish Space Corporation, Solna strandväg 86, SE-171 04 Solna, Sweden

The cooperation between ELGRA and ESA education office on student hand-on projects have been successfully expended with the new edition of the program Fly Your Thesis that completes the two other student programs Spin Your Thesis and Drop Your Thesis offered by ESA education office.

ELGRA have during these last years supported ESA education office in the selection of student teams and by offering the support of ELGRA mentors who are providing the student group with expertise in the field of gravity research over the entire duration of their project.

These programs have allowed many students from all over Europe to discover gravity research using ground based facilities as the large diameter centrifuge (LDC, ESA ESTEC centre, NL) for Spin Your Thesis, a 146 meter Drop Tower at ZARM (Bremen, DE) for Drop Your Thesis and parabolic flight for Fly Your Thesis.



Students during parabolic flight during the Fly Your Thesis 2016 campaign (Photo credit: ESA).

### Spin Your Thesis

In October 2016, two enthusiastic student teams have launched their experiment at ZARM. STAR team, from University of Padova, tested a mechanism to deploy and retrieve a filamentous tether, whilst the Break Team from Queen Mary University of London and University of Seville investigated the break-up of colloidal liquids.

### Drop Your Thesis

In October 2016, two enthusiastic student teams have launched their experiment at ZARM. STAR team, from University of Padova, tested a mechanism to deploy and retrieve a filamentous tether, whilst the Break Team from Queen Mary University of London and University of Seville investigated the break-up of colloidal liquids.



Preparing a syringe for hypergravity droplet generation (Photo credit: ESA).

### Fly your thesis 2016

In November 2016, four teams of university students conducted their experiments during the 65th ESA parabolic flight campaign, this project will remain for them an extraordinary experience. The TEPiM team from the Universidad Politécnica de Madrid (UPM) in Spain studied the melting process of Phase Change Materials in weightlessness conditions. The CFVib team, also from UPM, investigated the behaviour of fluids subjected to high frequency low amplitude vibrations. The Italian team PoliTethers from Politecnico di Milano tested the control dynamics and algorithms for tether-based systems, in view of possible future applications to tow space debris to be deorbited, and the team from the Universität Duisburg-Essen in Germany, Anemoi4 examined the wind speeds needed to lift dust in an Martian-like atmosphere.

### Outlook

We are now looking forwards reading about the students' exiting findings that should be soon reported. In the meanwhile, we have been working on the selection of new motivated students for the new edition of these three programs which are already planned for 2017.



For more information, please visit ESA education office website:  
[http://www.esa.int/Education/Fly\\_Your\\_Thesis](http://www.esa.int/Education/Fly_Your_Thesis)

[http://www.esa.int/Education/Drop\\_Your\\_Thesis](http://www.esa.int/Education/Drop_Your_Thesis)  
[http://www.esa.int/Education/Spin\\_Your\\_Thesis](http://www.esa.int/Education/Spin_Your_Thesis)



Fly Your Thesis 2016 selection workshop in The Hague (NL) with the contribution of ELGRA's general secretary Dr. Carole Leguy (Photo: ESA).



Promoting ELGRA in Portugal (Photo: Dr. Carole Leguy).

## ESA academy helps summer students make light work of a heavy subject

Choosing your future job can be pretty heavy task. So, ESA decided to lighten the load for 22 European university students with a summer school. Between Monday 27 June and Friday 1 July 2016, the young adults gathered at the ESA Academy Training and Learning Centre, Redu, Belgium to spend the week learning about gravity-related science.



Presentation of the ESA Education opportunities for tertiary students. 7 July 2016

The students were chosen from 18 different universities across 9 ESA Member States. Part of the selection criteria was that, although they were following scientific or engineering paths, they were not already involved in the space sector.

The summer school was organised by the ESA Education Office and ELGRA (the European Low Gravity Research Association). It is their first joint gravity-related research summer school to be organised, and it covered all aspect of research that plays with the strength of gravity to create novel experimental conditions.



Team work.

Although the strength of gravity itself cannot be turned up and down, various techniques can be used to mitigate or enhance its effects. ESA experts explained the techniques and the life-cycle of experiments at the European Space Agency.

Microgravity is created in experiments that are allowed to fall

freely, for example by being dropped in a capsule down an evacuated tower. At the other end of the scale, hypergravity can be created in a centrifuge that spins to create an acceleration that enhances the pull of the force.

The aim of the summer school was to introduce gravity-related research to future scientists and engineers by showing the possibilities of studies and research careers in the European space sector. Recruiting fresh talent will be essential if Europe is to continue being a world player in space.

Judging by the comments from some of the students, these goals were achieved. "A great and unique opportunity to know more about an interesting topic not explained at university. I completely recommend this Summer School," says student Aleix París Bordas from Polytechnic University of Catalunya, Spain.



Lecture given by Monica Monici, ELGRA President.

Over the course of the week, 13 ELGRA researchers from all across Europe shared their expertise. This included their backgrounds, descriptions of their day-to-day work, and the results of their gravity-related research in biology, human physiology and physics. To complete the roster of speakers, former Spin Your Thesis! and Drop Your Thesis! students presented their projects and lessons learned, and gave tips.

"The ESA gravity-related research summer school is a great experience. The combined presence of experts and students from various backgrounds resulted in a very informative week that increased my passion about Space even more," says student Tim Hermans from Delft University of Technology, The Netherlands.

The students were also told by ESA representatives about the various ESA Education programmes that allow university students to develop and run their own gravity-related experiments. Each of these programmes are made in a way that mimics the running of real space projects, providing the students with invaluable experience in how the space sector works.

"The opportunity to meet and work with students from different disciplines and countries has been an incredibly unique experience. I highly recommend attending the ESA/ELGRA Gravity-Related Research Summer School to anyone with a budding interest in space science. It's been a really fantastic week filled with many fun and interesting activities, enjoyed alongside some great people," says student Rebecca Diez from University of Warwick, UK.

When not in the lecture room, the students got to visit a number of professional space establishments to further open the window into the world of space. First was the one on their doorstep, the ESA Redu Centre, which is one of the agency's tracking stations. Here they learnt about ESA's operational activities as well as about



the experimental Proba and navigational Galileo programmes.

Next on the itinerary was the Euro Space Centre, a science museum and educational tourist attraction devoted to space science and astronautics. Finally, the Centre Spatial de Liège, which is an applied research centre owned by the University of Liège. Here the work is focused on design, integration and calibration of space instrumentation.



Former Drop Your Thesis! student presenting her team's project.

"This summer school gave me the opportunity to discover a new field of space research and engineering through passionate experts and students. Finally it gave me the chance to work inside a team

of students from different countries and backgrounds on a concrete project," says student Guillaume Thirion from National School of Civil Aviation, France.

The final task for the students was to form teams of 4 and 5 and come up with an idea for future gravity-related experiment that could be performed on a microgravity or hypergravity platform, or even on the International Space Station itself.

"One of the best parts about the school was how international it is. It is rare to have a mix that is truly varied – even when something is open to all nationalities, one tends to dominate. This was not the case at ESA, where truly interested and intelligent students from all over Europe came together," says student Adriaan Hilbers from University of Oxford.

"A well organised, highly sophisticated and well accomplished procedure of awareness, knowledge, science, fun and social activity. In these difficult times, sponsored educational programmes by ESA are more than welcome, they are needed," says student Vlachopoulos Odysseas from University of Peloponnese, Greece.

The value of the experience was not lost on the organisers either. "Creating moments of inspiration, community and curiosity, the ESA/ELGRA summer school has been a wondrous week, one that I am grateful to of been part of. Watching students being enthused each day, passionate about pursuing both answers and questions is truly what great educational experiences are made of," says Philip Carvil, of SELGRA (the student association of ELGRA).

As the students returned home, it was in the knowledge that this may not be the last time they work for ESA or European space industry again.



Group photo.

## SELGRA Activities – ELGRA Newsletter

It is with great enthusiasm and satisfaction that we completed another year where SELGRA took once more a leading role at promoting and encouraging gravity-related research among European students. During this past year, SELGRA actively participated in different exciting space-related conferences and events, including the 1st edition of the Training Week for ESA's hands-on programmes and the ESA-ELGRA Gravity-Related Research Summer School, both meetings hosted at the new ESA Academy Training and Learning Centre located at the ESA's Redu centre, Belgium. Not only SELGRA was regularly in close contact with students, contributing to their education and early space-related careers, but also recruited an increasing number of some of the most promising minds around Europe. Indeed, today's membership is surpassing our expectations with more than 100 student members enrolled in our society, corresponding to a significant increase in comparison to last year.

In August 2016, three SELGRA conference grants were awarded to European students that successfully presented their research aboard. At the end of the year, SELGRA launched the Points of Contact (PoC) programme, where members will have the opportunity to take on the role of official liaisons of their respective countries to further stimulate students' proactivity and improve their soft skills. At its own way, SELGRA continues to promote and encourage gravity-related studies, making an effort to represent the common interest of its members. In this newsletter we highlight some of our activities that stood out this past year.

### SELGRA at ESA Academy

From the 14th to 17th of March we gathered at ESA's Redu centre to participate in the inauguration of the ESA Academy. This pioneering event counted with the presence of some ESA and hands-on programme invited experts as well as with the new recruits of the Spin Your Thesis! And Drop Your Thesis! programmes. It was four fantastic days talking about gravity-related research at the highest level, where students not only learned about a wide range of subjects, including for example, project management, risk assessment, spacecraft design, but, as highlighted by our SELGRA delegate Daniel Carvalho, also "had the opportunity to get to know better SELGRA's mission and its funding opportunities for early space-related careers".



SELGRA participation in the 1st edition of the Training Week for ESA's hands-on programmes.



ESA/ELGRA Gravity-Related Research Summer School.

Nearly four months later, SELGRA attended and helped organizing the ESA/ELGRA Gravity-Related Research Summer School held at the ESA's Redu centre, which aimed at offering a solid overview of current research in life and physical sciences conducted in altered gravity conditions to bachelor and master students from across Europe. As stated by SELGRA president Miguel Ferreira, the ESA-ELGRA Summer School "was an incredible opportunity to reach out some of the brightest science and engineering students in Europe and show them some of the work that has been developed in altered gravity research". Catarina Martins Costa, a Portuguese student that attended the Summer School, also shared similar thoughts, considering that this event promoted "an exciting clash of ideas that undoubtedly broadens the horizons of each one of the participants". She also highlighted the key role of SELGRA as "a unique platform that provides students with opportunities to share and discuss exciting new ideas and (...) as a key launching ramp for young minds interested in the field of gravity-related science".

### 2016 Conference grants

As part of SELGRA's mission to support and encourage students at the beginning of their careers to communicate their gravity-related research among the European scientific community, the Summer and Winter calls for the SELGRA conference grants were successfully opened. This past year, three summer grants, each one covering up to €700 in conference-related, travel and accommodation expenses, were awarded to PhD students Alessandra Cazzaniga, Angelique Van Ombergen and Maria C. Vlachou. Alessandra presented her results on how simulated microgravity can affect the stemness of mesenchymal stem/stromal cells (MSCs) at the 3rd Joint Meeting of Pathology and Laboratory Medicine hosted in Pescara, Italy. According to the student, her work "provoked great interest among Italian and foreigner pathologists", making the audience defining "space research as the Research of the Future". Also concerning the life science field, Angelique Van Ombergen attended to the Symposium in Bio-Neuroscientific Approaches of life in space and extreme environments in Corfu, Greece. Angelique showed how the brain adapts to microgravity, particularly, how the exposure to parabolic flights can affect brain structure and function. Last but not least, Maria Vlachou from the Aristotle University of Thessaloniki, Greece had the opportunity to participate in the 11th International Conference on Two-Phase Systems for Space and



Ground Application (ITTW 2016) held in Marseille, France. The presented work was focused in understating the effect of increased gravitational acceleration on flow boiling incipience, which might have a strong impact in two phase thermal management systems widely used in power plants and even by the space industry. As in previous editions and highlighted by this years' students, SELGRA grants have worked as a great interesting opportunity for young students to share their research and learn with a wide range of experts of the field:

*research in the scientific community."*

Alessandra Cazzaniga

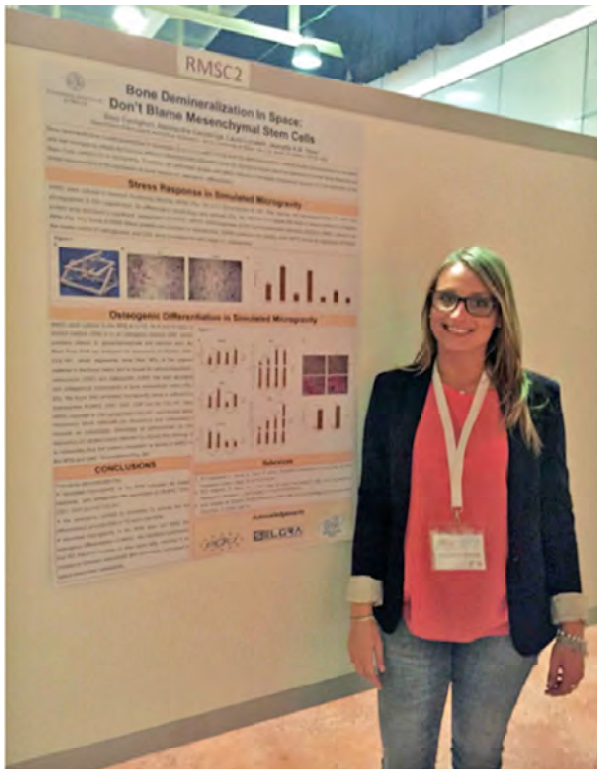

Alessandra Cazzaniga

*"I am very grateful for the opportunity to disseminate space*

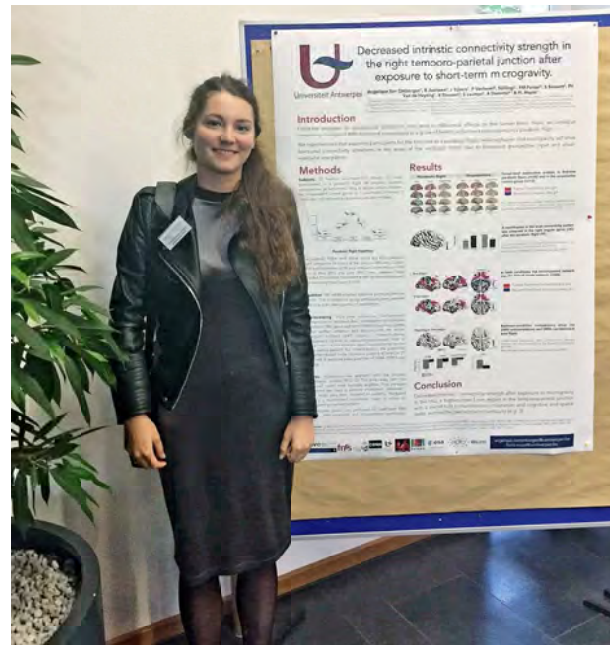

Angelique Van Ombergen

*"I would encourage other young researchers to apply for the SELGRA conference grant, as it is a great opportunity to present your work abroad and discuss it with colleagues and experts from around the world."*

Angelique Van Ombergen

*"Attending this conference and its sessions was a great opportunity for me to learn more about my field and also to meet important people of this science community."*

Maria C. Vlachou





## Microgravity Science and Technology

You are ELGRA member and one of your professional ambitions is to understand the effects of gravity and use for that the unique environment of spaceflight for research.

You just presented your results at a meeting related to microgravity research. Did you think about publishing them in the journal *Microgravity Science and Technology*?

Experience says that scientists should pursue two goals (at the minimum):

- (a) to publish highlighting microgravity results in the best journals with highest impact factor;
- (b) to publish in journals where the colleagues will easily find them and contribute to the impact of these journals.

And for the second option, the Microgravity Science and Technology (MST) journal fits the best. ELGRA society keeps close relations with MST journal through the years. If you are the coordinator of a Topical Team or the organizer of a scientific meeting, you are welcome to propose a special issue (but not a proceedings issue) to the journal in which hot topics are discussed in detail.

Microgravity Science and Technology publishes studies performed on and prepared for platforms that provide realistic microgravity conditions and on ground-based facilities aiming to simulate microgravity effects on Earth or providing artificial gravity conditions (such as centrifuges).

Let me remind you that, as ELGRA member, you have free access to the MST via the ELGRA website. But note that MST also offers an open access option. Publishing your results in the Microgravity Science and Technology will demonstrate to ESA and national agencies the interest to continue support of microgravity-related research in the future.

MST offers short publication times – the reviewing and publication process takes only a few months. And by submitting good papers to the journal you will help increasing its impact factor and thereby contribute to further establishing it as the interdisciplinary microgravity community journal.

Do not allow to your results to be lost in the increasingly scattered scientific publishing field.

Valentina Shevtsova  
Editor-in-Chief  
Microgravity Science and Technology journal



### Proto Pippia †

We are writing these words of sorrow here in Sardinia quite near to Proto's birth- and farm house in the company of sheep, cows, boars and the cold strong wind of the winter.

End of November Proto sent us a dramatic e-mail informing on his illness. Our contacts with his wife Caterina let us hope that a cure was still possible. Even one day before he passed away on December 12th his son Gianni told us that there still was hope. The day after Caterina informed us that Proto, aged of 69 years, was no more with us. We arrived here from Zurich on December 16th and we could not make on time to participate to his funeral on the 14th. We are very sad.



Proto Pippia preparing the culture of human lymphocytes for the flight on the sounding rocket MASER 9 in Kiruna, 2002.

Proto brilliantly graduated 1970 in Biological Sciences at the University of Sassari in Sardinia. He started his career as assistant to the chair of General Physiology; 1985 became associated and 2007 full professor at the same university.

We met Proto for the first time in 1978 on occasion of the presentation in Sassari of our Spacelab project. One year later he spent a stage of a few months in our laboratory at the ETH-Zurich. There he was contaminated by the virus of Space and Gravitational Biology. A fruitful friendship and collaboration was started. Thanks to him we were able to buy a piece of land and build our own house close to his one. Our collaborative work was generously supported by the Agenzia Spaziale Italiana ASI. He was able to install in his laboratory a fast rotating clinostat and a hyper-g centrifuge that allowed to conduct important ground-based investigations.

Our common work was characterized by several highlights comprising experiments in Spacelab, Spacehab, International Space Station and sounding rockets. We experienced also a dramatic drawback when years of work were lost in the tragic accident of Columbia in 2003. Thanks to his experience and scientific competence he promoted fruitful collaborations in Space Biology with several Italian universities. Proto conducted also studies in hematology, in particular on thalassemia. Several publications in important international journals document the success of his work.

Proto dedicated his free time to gardening, culinary art, bridge and tennis. He was the cofounder of the Sassari branch of the

Italian Kitchen Academy. We remember his strenuous fight 1994 against a giant lobster in the kitchen of our apartment in Cocoa Beach while preparing the experiment for the International Microgravity Laboratory or the delicious "spaghetti ai ricci di mare" (spaghetti with sea urchins eggs) waiting for the launch of the sounding rocket Maser 9 in 2002 at Esrange near Kiruna in Sweden.

With Proto we have lost a great friend and a very helpful and collaborative colleague.

We are missing you.

Augusto and Marianne Cogoli  
Sassari, December 2016

### Professor Dr. Eberhard Horn †

With sadness the ELGRA community addresses the death of Prof. Dr. Eberhard Horn. He passed away on September 12, 2016, losing the struggle against an aggressive cancer disease. From 1993 to 2008 he used 3 NASA-Shuttle, 5 Sojuz missions, one satellite mission and 2 parabolic flight campaigns to perform neurobiological experiments with tadpoles, fish, crickets, flies and scorpions, nine of them as a principal investigator.



Prof. Eberhard Horn after his successful last Sojuz mission in 2008.

The most fundamental and extensive ones were those performed with *Xenopus laevis* tadpoles. By studying the vestibulo-ocular reflex during different developmental stages under microgravity he proved that a critical period exists in the development of the sense of gravity - similarly as it is known from the development of vision since decades. In 2011, he published the results under the title "Gravity-Related Critical Periods in Vestibular and Tail Development of *Xenopus laevis*" in the Journal of Experimental Zoology.

Born on August 1, 1942, in Frankfurt (Oder) Eberhard Horn studied biology and mathematics at the Johann Wolfgang Goethe University in Frankfurt am Main. His scientific education has been

affected by the spirit of the German understanding of comparative behavioral research taught by Martin Lindauer in the tradition of the Noble Prize Winners Karl von Frisch and Konrad Lorenz. Additionally he was influenced by the upcoming cybernetics, which allowed the modeling of regulatory processes in behavioral science.

From the very beginning the gravitational sensory system in insects was of great interest to him. His dissertation focussed on the geotactic behavior of bumble bees and honey bees and the influence of gravitational stimuli. Later studies dealt with the influence and interaction of gravitational and visual stimuli in moving insects. They were performed at Zurich University (Switzerland), as well as at Karlsruhe University (now Karlsruhe Institute of Technology) in Germany; here, he held an associated professorship until his retirement in 2007. During his Karlsruhe period he took a sabbatical in order to improve his knowledge in insect neurophysiology at the Zoological Institute of the University of Cambridge (Malcolm Burrows); furthermore he started vestibular research in *Xenopus laevis*.

In 1985, changes in Eberhard Horn's scientific life arose from three persons: Hans Helmut Kornhuber, head of the Department of Neurology at the University Hospital of Ulm, gave him the chance to establish his own research group "Experimental Neurology and Gravitational Physiology" with an emphasis on experimental epilepsy; Ottavio Pompeiano, head of the Institute of Physiology at the Medical Faculty of the University of Pisa (Italy) invited him to study the regulation of vestibulo-spinal reflexes and their pharmacological manipulation in cats; and last but not least Wolfgang Briegleb, a pioneer in space biology from the German Aerospace Center DLR, convinced him to use space flights to study the influence of microgravity on the development of the sense of gravity.

The German Spacelab mission D2 showed Eberhard Horn the way. In contrast to young *Oreochromis* fish *Xenopus* tadpoles responded to the deprivation of gravity as recognized by changed vestibulo-ocular reflexes. Henceforth his aim was to verify a critical period during the development of the sense of gravity. At that time he never suggested it would last him 15 years; in 2008, the Soyuz mission TMA13/TMA12 fulfilled his dream.

As a hard-working and open-minded scientist he appreciated the interdisciplinary discourses with his colleagues worldwide and the cooperation with research groups from Nancy, Toulouse, Madrid and Ismailia (Egypt) during the different space missions. Many of

Eberhard Horn's proposed space projects were selected by the different international space agencies to be flown in space. Due to the support of the agencies and due to his worldwide scientific cooperation and reputation he was lucky that most of his proposals could be realized in space. With his different topics he contributes fundamentally to the subject area of Neurobiology of the German national space program. The space management within the German Aerospace Center DLR appreciated very much his fully activities, his reliable cooperation and his deep belief in space research under weightlessness.

Furthermore he enjoyed working together with engineers of the space companies OHB, EADS or Kayser Italia to design new survival systems for small animals or to advance incubators like STATEX and BOTEX. Because of his expertise he was appointed member of the Insect Habitat Committee for the ISS. Initiated by Wolfgang Briegleb he wrote a draft program already in 1985 to establish Gravitational Biology as a specific field in animal research. After years he recognized a chance of realization by supporting Ulf Merbold, Germany's first astronaut, to be appointed professor for space technology at the University of Ulm. Unfortunately, the political framework did not match.

Eberhard Horn was not only an engaged scientist but also an empathetic university teacher and author of two textbooks, one about comparative sensory physiology. During his scientific career he published a monography about brain-based protective mechanisms during epileptic activity and nearly 200 articles and reviews in his research fields. Inspiring young scientists and his own students as well as pupils was important to him. During the French Andromede Mission to the ISS he was responsible of the German part of a French-German-Russian school project. In the course of the project "Zoom-into-Science" young pupils visited his lab at the University of Ulm to mention only one of his public activities.

Eberhard Horn was member of ELGRA from 2000 to 2015. In 2001, he also joined the American Society for Gravitational and Space Research, where he served on the Board of Governors from 2003 to 2006. He will remain in our minds as an extraordinary person and colleague, convinced that science needs both enthusiasm and patience.

Ulrike Friedrich, Jack van Loon and Monica Monici



Announcement of the  
**7th International Symposium on Physical Sciences in Space (ISPS-7)  
25th European Low Gravity Research Association Biennial Symposium and General  
Assembly (ELGRA-25)**

October 2–6 , 2017, Conference Centre of Antibes, Antibes, Juan-les-Pins, France

## SCOPE

This 7th ISPS symposium is jointly organized by ESA (European Space Agency) and ELGRA (European Low Gravity Research Association). It is the major international scientific forum for researchers in physical and life sciences utilising the space environment, in particular microgravity. The symposium is intended to inspire and encourage cross-cutting discussions between different scientific communities working in the same environment. It is intended to inspire and encourage cross-cutting discussions between different scientific communities working in the same environment. Contributions are solicited discussing results of experiments carried out on drop towers, parabolic aircraft flights, sounding rockets, unmanned recoverable capsules and, last but not least, the International Space Station ISS. Research areas include Physical Sciences, Biology, Human Physiology and interdisciplinary projects. In addition, instrumentation for experiments in space will also be discussed.

In order to stimulate discussions, parallel sessions will be limited to a minimum, and a number of key note lectures are planned to present an overview of and an introduction to latest advances in the field. In addition to oral presentations, a special emphasis will be given to posters. Dedicated poster sessions will provide ample time for in-depth discussions of their contents with interested colleagues.

## TOPICS

### Physical Sciences

- Ultra-precise cold atom sensors, quantum information and high energy particles
- Soft of complex Matter
- Boiling, evaporation and heat transfer
- Advanced material processing

### Biology

- Astrobiology
- Biology under non-Earth gravity conditions
- Supporting Life in hostile environments

### Human Research

- The Human body under space conditions: adaptations and countermeasures
- Psychological and neurosensory adaptations to reduced gravity, isolation and confinement

### Interdisciplinary or curiosity-driven projects

- Cosmic Radiation Risks for Human Exploration of the Solar System
- Energy storage
- Fire safety
- Cardiovascular fluid physics
- Hibernation and Torpor

### Instrumentation for experiments in space and microgravity platforms

## WEBSITE & CONTACT

ESA Conference Bureau

Email: [esaconferencebureau@atpi.com](mailto:esaconferencebureau@atpi.com)

Tel.: +31 (0) 71 565 5005

Scientific questions: [Astrid.Orr@esa.int](mailto:Astrid.Orr@esa.int)

Website: <http://esaconferencebureau.com/2017-events/17a02/home>

