

IC Recorder
ICD-PX470



Use this Help Guide when you have any questions on how to use your IC recorder.

Preparation

Parts and controls

HOME menu/OPTION menu

Using the HOME menu

Using the OPTION menu

About folders and files

Display window

While the HOME menu is displayed

While recording is in progress or on standby

While playback is in progress

While the recording information is displayed

While the current file information is displayed

While the file search categories are displayed

Power

Inserting batteries

Using the IC recorder with the USB AC adaptor

Disconnecting the IC recorder from the USB AC adaptor

Turning the power on

Turning the power off

Memory card

Inserting a memory card

Making the initial settings

Preventing unintentional operations

Placing the IC recorder into the HOLD state (HOLD)

Releasing the IC recorder from the HOLD state

Maintaining the volume level (European model only)

Maintaining the moderate volume level (European models only)

Recording

Recording

Recording with the built-in microphones

About the recording level guide

Monitoring the recording audio

Additional operations available during recording

Changing the file storage destination folder

Additional recording operations/settings

Selecting a recording scene for an individual situation

Selecting the recording function (Focused/Wide)

Tips for better recording

Default settings for the recording scenes of the Scene Select function

Recording automatically in response to the input sound volume – the VOR function

Recording with other devices

Recording with an external microphone

Recording audio from an external device

Using external devices for recording

Recording the playback audio of the IC recorder on an external device

Playback

Playing

Playing a file

Selecting a file

Additional operations available during playback

Additional playback operations/settings

Reducing noise in the playback audio to make human voices sound clearer – the Clear Voice function

Using the transcription playback mode

Adjusting the playback speed – the DPC (Digital Pitch Control) function

Selecting the playback mode

Specifying a segment of a file to play repeatedly (A-B repeat)

Continually playing the current file (Button-hold repeat playback)

Specifying the playback range in the stored file list

Listening to sound with better quality

Searching forward/backward (Cue/Review)

Locating the desired playback point quickly (Easy Search)

Editing

Deleting

Deleting a file

Deleting all files in the searched folder or list

Deleting a folder

Organizing files

Moving a file to a different folder

Copying a file to a different folder

Creating a folder

Using track marks

Adding a track mark

Adding track marks automatically

Deleting a track mark

Deleting all the track marks in the selected file at one time

Dividing files

Dividing a file at the current playback point

Dividing a file at all the track mark points

Protecting a file

Settings menu

Using the Settings menu

List of the Settings menu items

Menu items with selectable setting items

Selecting the recording mode (REC Mode)

Selecting the sensitivity level of the built-in microphones (Built-In Mic Sensitivity)

Reducing noise during recording (Recording Filter)

Selecting the audio input type and the sensitivity level of the external microphone (Ext. Input Setting)

Turning the operation indicator on or off (LED)

Selecting the display language (Language)

Setting the clock (Date&Time)

Selecting the date display format (Date Display Format)

Selecting the clock display format (Time Display)

Turning the beep sound on or off (Beep)

Setting the time period before the IC recorder automatically turns off (Auto Power Off)

Resetting all menu settings to the default ones (Reset All Settings)

Formatting the memory (Format Built-In Memory/Format SD Card)

Checking the remaining recording time (Available Rec. Time)

Checking the information about the IC recorder (System Information)

Computer

Connecting the IC recorder to a computer

Disconnecting the IC recorder from the computer

Structure of folders and files

Copying files from the IC recorder to a computer

Copying music files from a computer to the IC recorder

Playing music files on the IC recorder that were copied from a computer

Using the IC recorder as a USB storage device

Software

What you can do with Sound Organizer 2 (for Windows only)

System requirements for Sound Organizer 2

Installing Sound Organizer 2 (for Windows only)

The Sound Organizer 2 window (for Windows only)

Specifications

Compatible memory cards

System requirements

Technical specifications

Maximum recording time

Maximum playback time/number of music files

Battery life

Announcements

Precautions

Safety regulations

Trademarks

Notice for users

License

Support website

Customer support websites

If you have problems/Troubleshooting

Troubleshooting

Noise

The recorded file is noisy and is hard to understand.

The recorded file is noisy and you want to record with less noise.

A rustling noise is recorded.

A buzzing or humming noise is recorded.

Noise is recorded when you use an external microphone (not supplied) for recording.

You hear noise when using headphones (not supplied) for playback.

The volume of the audio you recorded from an external device is low or you hear squeaking noises when you listen to the audio via the built-in speaker.

You hear noise during playback even with the Clear Voice function turned on.

Power

The IC recorder does not turn on or pressing any button does not work.

The IC recorder does not turn off.

The IC recorder automatically turns off.

The battery life is short.

General operations

The IC recorder does not operate correctly.

The operation indicator does not light.

Recording

You cannot record a file.

Recording is interrupted.

The input audio volume is too loud or not loud enough when you record audio from an external device.

Playback

The playback volume is low.

You hear no sound from the built-in speaker.

- You hear sound from the built-in speaker even when headphones (not supplied) are connected.

- Playback speed is too fast or too slow.

Editing

- You cannot divide a file.

- You cannot move a file.

- You cannot copy a file to a different folder.

- The folder or file you created is not displayed.

Clock

- The recording date of a file appears as "----/--/--" or "--:--."

- The clock setting is reset.

Display

- The remaining recording time on the display window is shorter than the one displayed on the computer.

Files

- The "Memory Full" message appears and you cannot start recording.

- The "File Full" message appears and you cannot operate the IC recorder.

- The microSD card is not detected.

Computer

- A folder or file name appears in unreadable characters.

- Copying a file takes time.

- The IC recorder is not detected by the computer and you cannot transfer folders/files from the computer.

- The file you transferred from the computer does not appear on the IC recorder and you cannot play the file.

- The computer does not start.

Software operations (Sound Organizer 2)

- You cannot install Sound Organizer 2.

- The IC recorder is not detected by Sound Organizer 2.

- The playback volume of the computer is low or you hear no audio from the computer.

- You cannot play or edit stored files.

- The counter or slider does not operate correctly or you hear noise.

- Operations slow down as the number of stored files increases.

The computer seems to freeze while a file is being saved, added, or deleted.

Sound Organizer 2 freezes during start-up.

List of messages

System limitations



Table Of Contents

Help Guide IC Recorder ICD-PX470.....	i
Preparation.....	i
Parts and controls.....	1
HOME menu/OPTION menu.....	i
Using the HOME menu.....	3
Using the OPTION menu.....	5
About folders and files.....	7
Display window.....	i
While the HOME menu is displayed.....	9
While recording is in progress or on standby.....	10
While playback is in progress.....	12
While the recording information is displayed.....	14
While the current file information is displayed.....	15
While the file search categories are displayed.....	17
Power.....	ii
Inserting batteries.....	19
Using the IC recorder with the USB AC adaptor.....	20
Disconnecting the IC recorder from the USB AC adaptor.....	21
Turning the power on.....	22
Turning the power off.....	23
Memory card.....	ii
Inserting a memory card.....	24
Making the initial settings.....	26
Preventing unintentional operations.....	ii
Placing the IC recorder into the HOLD state (HOLD).....	29
Releasing the IC recorder from the HOLD state.....	30
Maintaining the volume level (European model only).....	ii
Maintaining the moderate volume level (European models only).....	31
Recording.....	ii
Recording with the built-in microphones.....	32
About the recording level guide.....	35
Monitoring the recording audio.....	36
Additional operations available during recording.....	37
Changing the file storage destination folder.....	38
Additional recording operations/settings.....	ii
Selecting a recording scene for an individual situation.....	39
Selecting the recording function (Focused/Wide).....	41
Tips for better recording.....	43

Default settings for the recording scenes of the Scene Select function.....	46
Recording automatically in response to the input sound volume – the VOR function.....	47
Recording with other devices.....	iii
Recording with an external microphone.....	49
Recording audio from an external device.....	50
Using external devices for recording.....	iii
Recording the playback audio of the IC recorder on an external device.....	52
Playback.....	iii
Playing.....	iii
Playing a file.....	53
Selecting a file.....	55
Additional operations available during playback.....	56
Additional playback operations/settings.....	iii
Reducing noise in the playback audio to make human voices sound clearer – the Clear Voice function	57
Using the transcription playback mode.....	58
Adjusting the playback speed – the DPC (Digital Pitch Control) function	60
Selecting the playback mode.....	62
Specifying a segment of a file to play repeatedly (A-B repeat).....	64
Continually playing the current file (Button-hold repeat playback).....	66
Specifying the playback range in the stored file list.....	67
Listening to sound with better quality.....	69
Searching forward/backward (Cue/Review).....	70
Locating the desired playback point quickly (Easy Search).....	71
Deleting.....	iii
Deleting a file.....	72
Deleting all files in the searched folder or list.....	74
Deleting a folder.....	76
Organizing files.....	iii
Moving a file to a different folder.....	78
Copying a file to a different folder.....	80
Creating a folder.....	81
Using track marks.....	iv
Adding a track mark.....	82
Adding track marks automatically.....	84
Deleting a track mark.....	85
Deleting all the track marks in the selected file at one time.....	87
Dividing files.....	iv
Dividing a file at the current playback point.....	89

Dividing a file at all the track mark points.....	91
Protecting a file.....	93
Using the Settings menu.....	iv
List of the Settings menu items.....	94
Menu items with selectable setting items.....	iv
Selecting the recording mode (REC Mode).....	97
Selecting the sensitivity level of the built-in microphones (Built-In Mic Sensitivity).....	98
Reducing noise during recording (Recording Filter).....	100
Selecting the audio input type and the sensitivity level of the external microphone (Ext. Input Setting).....	102
Turning the operation indicator on or off (LED).....	104
Selecting the display language (Language).....	105
Setting the clock (Date&Time).....	106
Selecting the date display format (Date Display Format).....	108
Selecting the clock display format (Time Display).....	109
Turning the beep sound on or off (Beep).....	110
Setting the time period before the IC recorder automatically turns off (Auto Power Off).....	111
Resetting all menu settings to the default ones (Reset All Settings).....	112
Formatting the memory (Format Built-In Memory/Format SD Card).....	113
Checking the remaining recording time (Available Rec. Time).....	114
Checking the information about the IC recorder (System Information).....	115
Computer.....	v
Connecting the IC recorder to a computer.....	116
Disconnecting the IC recorder from the computer.....	117
Structure of folders and files.....	119
Copying files from the IC recorder to a computer.....	121
Copying music files from a computer to the IC recorder.....	123
Playing music files on the IC recorder that were copied from a computer.....	124
Using the IC recorder as a USB storage device.....	125
Software.....	v
What you can do with Sound Organizer 2 (for Windows only).....	126
System requirements for Sound Organizer 2.....	128
Installing Sound Organizer 2 (for Windows only).....	130
Sound Organizer 2 window (for Windows only).....	133
Compatible memory cards.....	135
System requirements.....	136
Technical specifications.....	138
Maximum recording time.....	141

Maximum playback time/number of music files.....	142
Battery life.....	143
Precautions.....	145
Safety regulations.....	148
Trademarks.....	150
Notice for users.....	151
License.....	152
Support website.....	vi
Customer support websites.....	153
Troubleshooting.....	154
Noise.....	vi
The recorded file is noisy and is hard to understand.....	155
The recorded file is noisy and you want to record with less noise.....	156
A rustling noise is recorded.....	157
A buzzing or humming noise is recorded.....	158
Noise is recorded when you use an external microphone (not supplied) for recording.....	159
You hear noise when using headphones (not supplied) for playback.....	160
The volume of the audio you recorded from an external device is low or you hear squeaking noises when you listen to the audio via the built-in speaker.....	161
You hear noise during playback even with the Clear Voice function turned on.....	162
Power.....	vi
The IC recorder does not turn on or pressing any button does not work.....	163
The IC recorder does not turn off.....	164
The IC recorder automatically turns off.....	165
The battery life is short.....	166
General operations.....	vi
The IC recorder does not operate correctly.....	167
The operation indicator does not light.....	168
Recording.....	vi
You cannot record a file.....	169
Recording is interrupted.....	170
The input audio volume is too loud or not loud enough when you record audio from an external device.....	171
Playback.....	vi
The playback volume is low.....	172
You hear no sound from the built-in speaker.....	173
You hear sound from the built-in speaker even when headphones (not supplied) are connected.....	174
Playback speed is too fast or too slow.....	175

Editing.....	vii
You cannot divide a file.....	176
You cannot move a file.....	177
You cannot copy a file to a different folder.....	178
The folder or file you created is not displayed.....	179
Clock.....	vii
The recording date of a file appears as “---/--/--” or “--:--”	180
The clock setting is reset.....	181
Display.....	vii
The remaining recording time on the display window is shorter than the one displayed on the computer.....	182
Files.....	vii
The “Memory Full” message appears and you cannot start recording.	183
The “File Full” message appears and you cannot operate the IC recorder.	184
The microSD card is not detected.....	185
Computer.....	vii
A folder or file name appears in unreadable characters.....	186
Copying a file takes time.....	187
The IC recorder is not detected by the computer and you cannot transfer folders/files from the computer.....	188
The file you transferred from the computer does not appear on the IC recorder and you cannot play the file.....	189
The computer does not start.....	190
Software operations (Sound Organizer 2).....	vii
You cannot install Sound Organizer 2.....	191
The IC recorder is not detected by Sound Organizer 2.....	192
The playback volume of the computer is low or you hear no audio from the computer.....	193
You cannot play or edit stored files.....	194
The counter or slider does not operate correctly or you hear noise.....	195
Operations slow down as the number of stored files increases.....	196
The computer seems to freeze while a file is being saved, added, or deleted.....	197
Sound Organizer 2 freezes during start-up.....	198
List of messages.....	199
System limitations.....	204

IC Recorder
ICD-PX470

Parts and controls

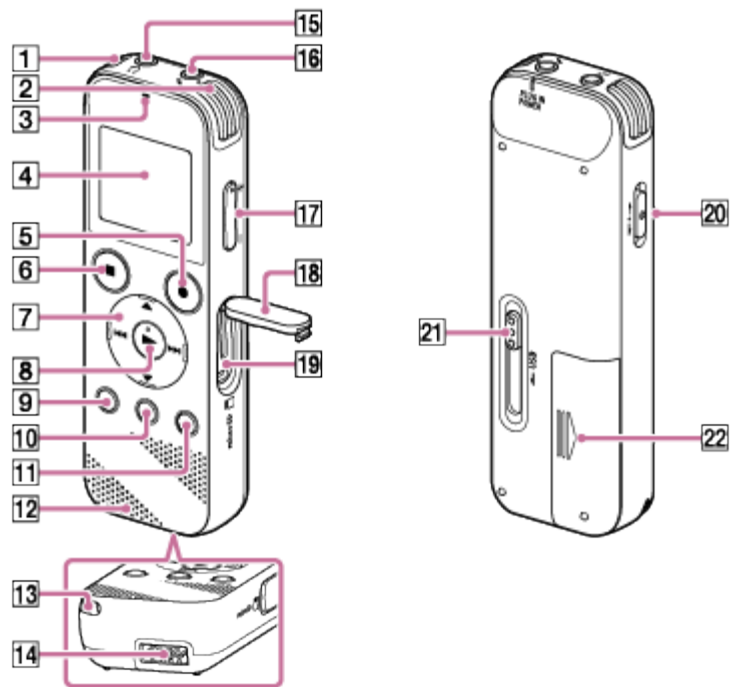

1. Built-in microphones (stereo) (L)
 2. Built-in microphones (stereo) (R)
 3. Operation indicator
 4. Display window
 5. ● REC/PAUSE (record/pause) button
 6. ■ STOP button
 7. Control button (▲ DPC (Digital Pitch Control), ▼ ↻ A-B (repeat A-B)/⏮ (review/fast backward), ▶▶ (cue/fast forward))
 8. ► (play/enter) button (*)
 9. ● BACK/ ● HOME button (● : press, ●● : press and hold)
 - 10 T-MARK (track mark) button
 - 11 OPTION button
 - 12 Built-in speaker
- Strap hole (No strap is supplied with your IC recorder.)

13

14 USB connector compartment

15  (headphones) jack

16  (microphone) (PLUG IN POWER) jack (*)

17 VOL $-/+$ (volume $-/+$) button (*)



18 Slot cover

19 microSD card slot (The card slot is located under the cover.)

20 HOLD•POWER switch

21 USB slide lever

22 Battery compartment

* The  (play/enter) button, VOL $-/+$ (volume $-/+$) button, and  (microphone) (PLUG IN POWER) jack have a tactile dot. Use the tactile dot as a reference when operating the IC recorder.

IC Recorder
ICD-PX470

Using the HOME menu

On your IC recorder, the HOME menu is the starting point for all functions. The HOME menu allows you to select a function, search for recorded files, or change the settings on the IC recorder.

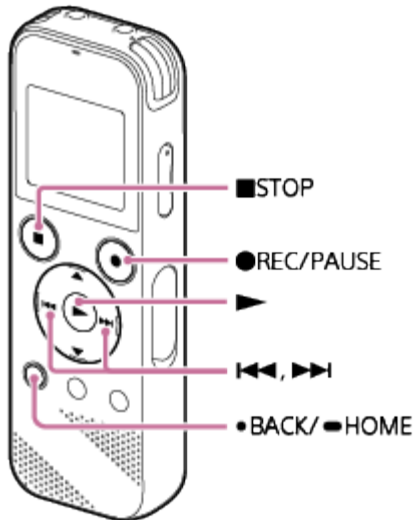

- 1 Press and hold BACK/HOME.

The HOME menu appears.

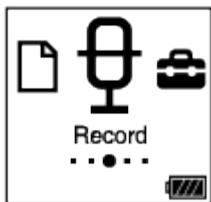

- 2 Press ◀◀ or ▶▶ to select the function you want to use, and then press ▶.

You can select the following functions:

🎵 Music:

You can select music files imported from a computer for playback.

To locate a music file, you can select one of the file search categories: "All Songs," "Albums," "Artists," and "Folders."

📄 Recorded Files:

You can select files recorded by the IC recorder for playback.

To locate a recorded file, you can select one of the file search categories: "Latest Recording," "Search by REC Date," "Search by REC Scene," and "Folders."

Record:



You can display the recording standby screen. To start recording, press ● REC/PAUSE.



Settings:

You can display the Settings menu and change various settings on the IC recorder.



Return to XX(*):

Select this function to return to the screen before you displayed the HOME menu.

* The function you are currently using is displayed in "XX."

Hint

- While the HOME menu is on the display window, you can press ■ STOP to return to the screen before you displayed the HOME menu.

Related Topic

- [Using the OPTION menu](#)

IC Recorder
ICD-PX470

Using the OPTION menu

You can display the OPTION menu by pressing OPTION. The OPTION menu items vary depending on the selected function of your IC recorder.

Note

- The OPTION menu may not appear, depending on the screen on the display window.

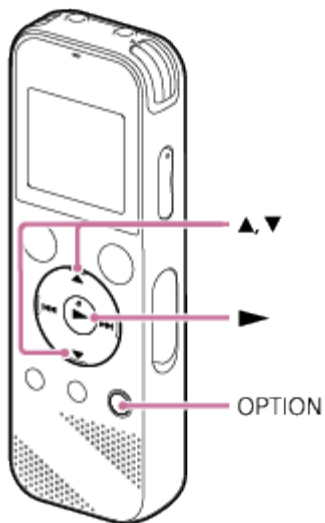

- 1 Select the function you want to use on the HOME menu, and then press OPTION.

The OPTION menu associated with the selected function appears.



- 2 Press ▲ or ▼ to select the desired menu item, and then press ►.

- 3 Press ▲ or ▼ to select the desired setting, and then press ►.

Hint

- To return to the previous screen, press BACK/HOME while the OPTION menu is on the display window.

Related Topic

- [Using the HOME menu](#)

4-595-548-31(1) Copyright 2016 Sony Corporation

IC Recorder
ICD-PX470

About folders and files

The following illustrates the structure of folders and files that you can view on your IC recorder.

Under “📄 Recorded Files”

“FOLDER01”: Files recorded via the built-in microphones are stored.

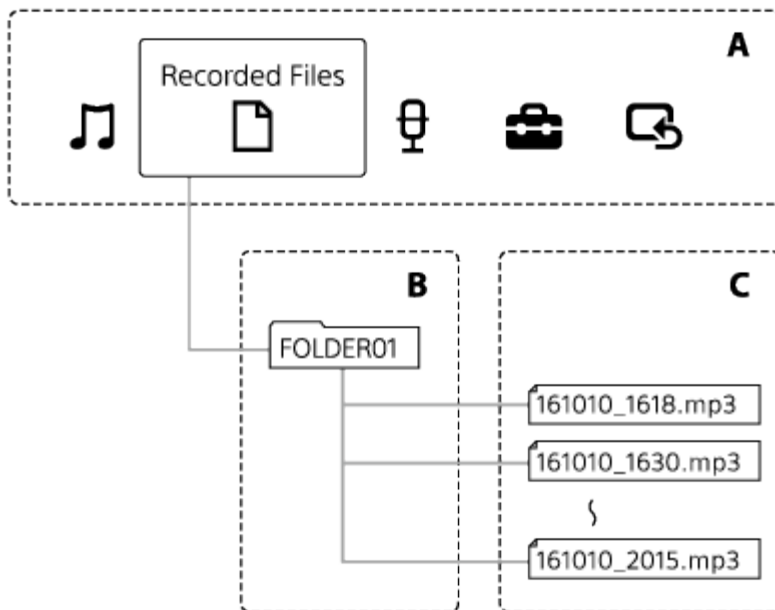

A: HOME menu

B: Folders

C: Files

Under “🎵 Music”

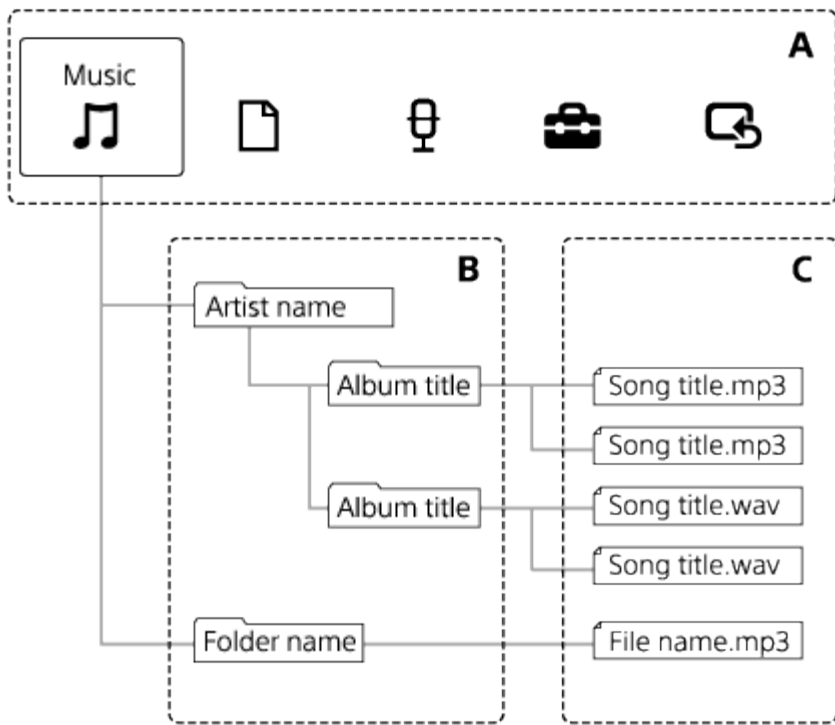

A: HOME menu

B: Folders

C: Files

Related Topic

- [Moving a file to a different folder](#)
- [Copying a file to a different folder](#)
- [Structure of folders and files](#)

IC Recorder
ICD-PX470

While the HOME menu is displayed

The following describes the HOME menu on the display window.

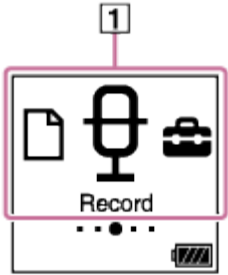

Note

- The above screen is provided for explanatory purposes. It may look different from what you actually see on your IC recorder.

1. HOME menu items

You can select one of the following:

- 🎵: Music
- 📄: Recorded Files
- 🎤: Record
- 🔧: Settings
- 🏠: Return to XX (The function you are currently using is displayed in “XX.”)

Related Topic

- [Using the HOME menu](#)

IC Recorder
ICD-PX470

While recording is in progress or on standby

The following describes the display window while recording is in progress or on standby.

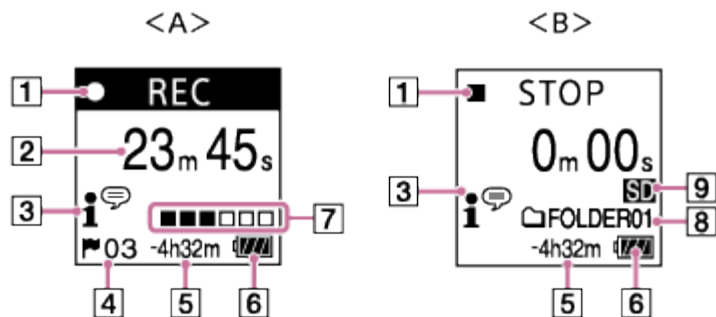

A: While recording is in progress

B: While recording is on standby

Note

- The above screen is provided for explanatory purposes. It may look different from what you actually see on your IC recorder.

- Recording status indicator
Indicates the current recording status of your IC recorder.

● REC	: recording
● PAUSE	: paused
■ STOP	: stopped

- Elapsed time
Indicates the elapsed time of the current recording.
- Scene Select indicator
Indicates the recording scene that is currently selected.
 - 🗨️ : Auto Voice Rec
 - 👥 : Meeting
 - 🎓 : Lecture
 - 🗨️ : Voice Notes
 - 👤 : Interview
 - 🎵 : Soft Music
 - 🎸 : Loud Music

- Track mark number
Indicates the number of added track marks.

- Remaining recording time
Indicates the remaining time available for recording in hours, minutes, and seconds.
10 hours or more: no indication

10 minutes to 10 hours: indicated in hours and minutes
Less than 10 minutes: indicated in minutes and seconds

6. Battery indicator

7. Recording level guide

Indicates the current recording volume level of input sound for your reference.

8. File storage destination folder

Indicates the destination folder for storing recorded files.

9. Memory storage indicator

Appears when the memory card is selected for storing recorded files.

IC Recorder
ICD-PX470

While playback is in progress

The following describes the display window during playback.

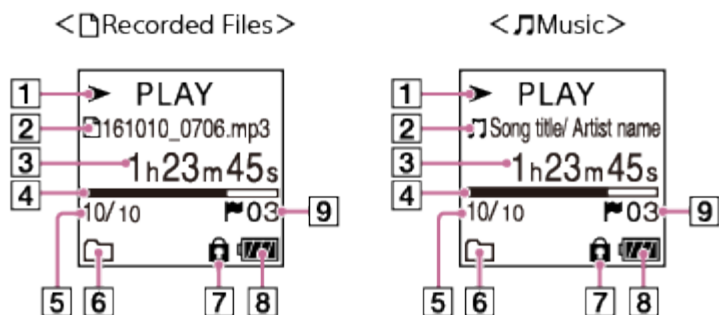

Note

- The above screens are provided for explanatory purposes. They may look different from what you actually see on your IC recorder.

- Playback status indicator**
 Indicates the current playback status of your IC recorder.
 - ▶ **PLAY** : playing
 - ◀◀/▶▶ : reviewing (fast-rewinding)/cueing (fast-forwarding)
 - **STOP** : on standby
 If the playback speed is modified, the DPC (Digital Pitch Control) speed will be indicated to the right of ▶ or ■.
- File information**
 Indicates information about the file you are playing.
 Files recorded with your IC recorder are indicated as follows:
 📁: File name: recording date_recording time.file format (e.g. 161010_0706.mp3)
 Music files are indicated as follows:
 🎵: Song title/Artist name
- Elapsed time**
 Indicates the elapsed time of the current playback.
- Playback progress bar**
 Indicates how far playback of the file has progressed.
- File number information**
 Indicates the file number of the playing file in the format (current file number)/(total number of files to play).
- Play Mode/Playback Range indicator**
 No indication: Normal (Play Mode)
 - ↺ : Repeat (Play Mode)
 - 1 : 1 File Play (Play Mode)
 - ↺1 : 1 File Repeat (Play Mode)

 : Shuffle (Play Mode)

 : Shuffle Repeat (Play Mode)

 : Selected Range (Playback Range)

7. Protect indicator

Indicates that the file you are playing is protected.

8. Battery indicator

9. Track mark number

Indicates the track mark number, if added, of the current playback point.

IC Recorder
ICD-PX470

While the recording information is displayed

You can view the recording information of your IC recorder, including the remaining recording time, the memory storage for recorded files, and the folder setting.

To display the recording information, while recording is on standby, select “REC Information” on the OPTION menu, and then press **▶**.



The following recording information is available:

Available Rec. Time:

Remaining time available for recording.

Recording Memory:

Memory storage (“Built-In Memory” or “SD Card”) for recorded files.

Recording Folder:

Storage folder for recorded files.

Scene Select:

Recording scene currently selected.

If the default settings for the Scene Select function are modified, “*” will appear to the left of the recording scene.

For information about the default settings, see [Default settings for the recording scenes of the Scene Select function](#).

REC Mode:

Recording mode currently selected.

Input:

Audio input type currently selected.

Mic Sensitivity:

Sensitivity level of the microphones currently selected.

Focused/Wide

“Focused” or “Wide” recording function currently selected.

Recording Filter:

Recording filter currently selected.

VOR:

VOR (Voice Operated Recording) setting currently selected.

Auto Track Marks:

Automatic track mark setting currently selected.

Hint

- While recording is on standby, you can press **■ STOP** to view the recording information of your IC recorder.

IC Recorder
ICD-PX470

While the current file information is displayed

You can view the information (recording date and time, file length, etc.) about the recorded file you selected.

Note

- The following screens are provided for explanatory purposes. They may look different from what you actually see on your IC recorder.

To view the information about a particular file, select a file you recorded with your IC recorder or a music file and select “File Information” on the OPTION menu. Then, you can press ▲ or ▼ to scroll up or down to view the following:

Information about the recorded file



- Rec Date/Time: Date and time when the file was recorded (year/month/day/time).
- File Length: Playback length of the file indicated in hours, minutes, and seconds.
- Model Name: Device by which the file was recorded. The same information for “Model:” in the “System Information” of the Settings menu appears.
- Scene Select: Recording scene selected at the time of recording.
- REC Mode: Recording mode selected at the time of recording.
- Mic Sensitivity: Sensitivity level of the microphones selected at the time of recording.
- Focused/Wide: “Focused” or “Wide” recording function selected at the time of recording.
- Recording Filter: Recording filter selected at the time of recording.
- VOR: VOR (Voice Operated Recording) setting selected at the time of recording.
- Input: Audio input type (“Built-In Mic,” “External Mic,” or “Audio IN”) selected at the time of recording.
- Location: Memory storage containing the file.
- File Path: Path to the file.



Information about the music file

File Length:
0h04m05s
Codec:
MP3

- File Length: Playback length of the file indicated in hours, minutes, and seconds.
- Codec: Codec type for music files.
- Bit Rate: Bit rate for music files.
- Sample Rate: Sampling rate for music files.
- Bit Depth: Bit depth for music files.
- Location: Memory storage containing the file.
- File Path: Path to the file.

IC Recorder
ICD-PX470

While the file search categories are displayed

When you select “ Recorded Files” or “ Music” on the HOME menu, the search categories of the stored files appear on the display window.

Note

- The following screens are provided for explanatory purposes. They may look different from what you actually see on your IC recorder.

When “ Recorded Files” is selected

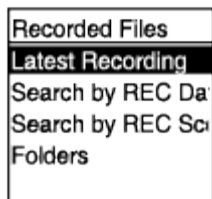

You can select one of the following search categories:

Latest Recording:

Starts playing the latest recording.

Search by REC Date:

Recorded files are sorted by recording date.

Search by REC Scene:

Recorded files are sorted by recording scene.

Folders:

Recorded files in the selected folder are listed.

When “ Music” is selected

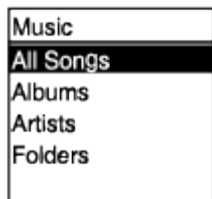

You can select one of the following search categories:

All Songs:

All music files are listed.

Albums:

Music files are sorted by album title.

Artists:

Music files are sorted by artist name.

Folders:

Music files in the selected folder are listed.

4-595-548-31(1) Copyright 2016 Sony Corporation

IC Recorder
ICD-PX470

Inserting batteries

1 Insert batteries.

Slide and lift the battery compartment lid in the direction of arrow, insert the supplied LR03 (size AAA) alkaline batteries with the correct polarity, and then close the lid.

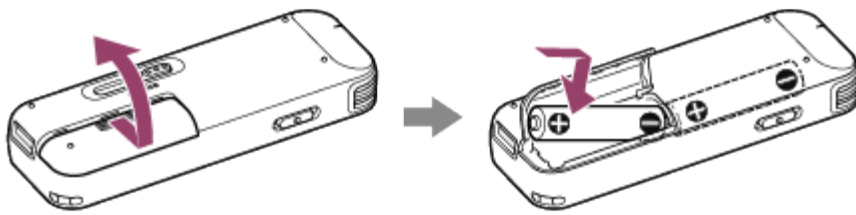

Note

- Before replacing batteries, be sure to turn off your IC recorder.
- When replacing batteries, be sure to use two brand-new alkaline batteries or two fully charged rechargeable batteries.
- Your IC recorder is not capable of charging rechargeable batteries. Use the battery charger (not supplied) for battery charging.

Hint

- Your IC recorder supports the following: (*)
 - LR03 (size AAA) alkaline battery (Two batteries are supplied with your IC recorder.)
 - Rechargeable battery (not supplied): NH-AAA-B2KN, NH-AAA-B2GN
 - Battery charger (not supplied): BCG-34HS2GN, BCG-34HW2GN

* Depending on the country or region of your purchase, some of the models or optional accessories are not available.

IC Recorder
ICD-PX470

Using the IC recorder with the USB AC adaptor

You can use your IC connector with a USB AC adaptor (not supplied) connected to an AC outlet. It is helpful to use the IC recorder with AC power when you want to record for a long time.

1 Connect a USB AC adaptor (not supplied) to an AC outlet.

2 Slide the USB slide lever of the IC recorder and connect the USB connector to the USB AC adaptor.

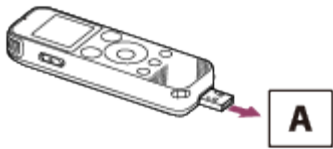

A: USB AC adaptor (not supplied)

Note

- While recording is in progress (the operation indicator lights in red) or paused (the operation indicator flashes in red), or while data is being accessed (the “Accessing” message is on the display window), observe the following to avoid data corruption:
 - Do not connect/disconnect your IC recorder to/from the USB AC adaptor while the adaptor is connected to an AC outlet.
 - Do not connect/disconnect the USB AC adaptor to/from an AC outlet while your IC recorder is connected to the adaptor.
- Be sure to connect the USB AC adaptor to a power outlet within reach so that you can immediately disconnect it when you detect any malfunctions.

Related Topic

- [Disconnecting the IC recorder from the USB AC adaptor](#)
- [Battery life](#)

IC Recorder
ICD-PX470

Disconnecting the IC recorder from the USB AC adaptor

Be sure to follow the procedure below, otherwise you may not be able to play the files stored on your IC recorder due to data corruption.

- 1 If recording or playback is in progress, press  STOP to stop the IC recorder.
- 2 Make sure that the “Accessing” message is not on the display window.
- 3 Disconnect the IC recorder from the USB AC adaptor, and then disconnect the USB AC adaptor from the AC outlet.

Note

- While recording is in progress (the operation indicator lights in red) or on standby (the operation indicator flashes in red), or while data is being accessed (the “Accessing” message is on the display window), observe the following to avoid data corruption:
 - Do not connect/disconnect your IC recorder to/from the USB AC adaptor while the adaptor is connected to an AC outlet.
 - Do not connect/disconnect the USB AC adaptor to/from an AC outlet while your IC recorder is connected to the adaptor.

Related Topic

- [Using the IC recorder with the USB AC adaptor](#)

IC Recorder
ICD-PX470

Turning the power on

- 1 Slide the HOLD•POWER switch to “POWER” and hold it until the display window turns on.

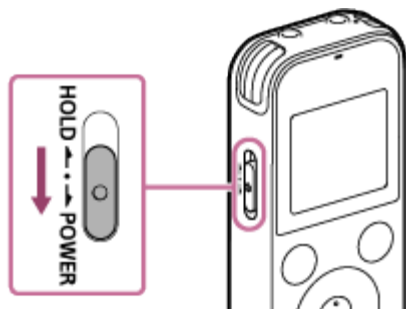

Hint

- The Auto Power Off function on your IC recorder is set to “10min” by default to save battery power. If you leave the IC recorder unused for 10 minutes, it will automatically turn off.

Related Topic

- [Turning the power off](#)

IC Recorder
ICD-PX470

Turning the power off

- 1 Slide the HOLD•POWER switch to “POWER” and hold it until “Power Off” appears on the display window.

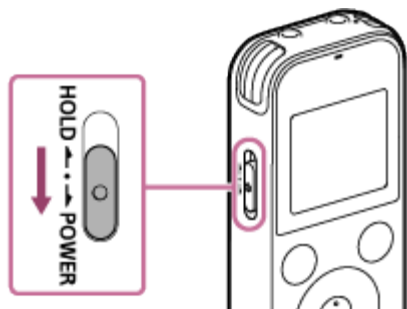

Note

- Before you replace the batteries, be sure to turn off the power.

Hint

- The Auto Power Off function on your IC recorder is set to “10min” by default to save battery power. If you leave the IC recorder unused for 10 minutes, it will automatically turn off.

Related Topic

- [Turning the power on](#)

IC Recorder
ICD-PX470

Inserting a memory card

In addition to the built-in memory, you can record files on a microSD card (not supplied).

- 1 Make sure that no IC recorder operations are in progress, and then open the cover of the microSD card slot.

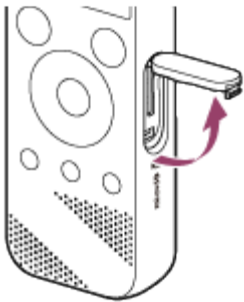

- 2 Hold a microSD card with the terminal side facing toward you and insert it into the microSD card slot until it clicks into place.

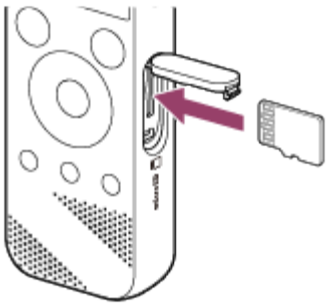

- 3 Close the cover of the microSD card slot.

Note

- Your IC recorder does not support microSDXC cards.
- If the microSD card is not detected by your IC recorder, remove it from the slot and then insert it back in.

- Successful operations with all types of supported microSD cards are not guaranteed.
- Keep any liquid and any metal or flammable object away from the microSD card slot to avoid a fire or shock hazard or malfunctions of your IC recorder.
- Before you start recording with a microSD card, we recommend that you copy all the data stored on the memory card to a computer and format the memory card on your IC recorder so it contains no data. For instructions on formatting the microSD card, see [Formatting the memory \(Format Built-In Memory/Format SD Card\)](#).

Hint

- To remove the memory card, push the microSD card into the slot. When it pops out, remove it from the microSD card slot.

Related Topic

- [Structure of folders and files](#)
- [Compatible memory cards](#)

IC Recorder
ICD-PX470

Making the initial settings

When you turn on your IC recorder for the first time, the Configure Initial Settings screen appears on the display window. You can then select the display language, set the clock, and turn on/off the beep sound.

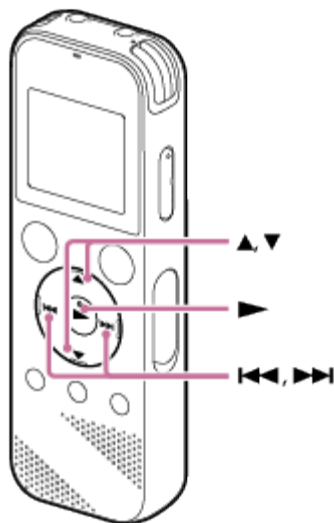

- 1 Press ► to select "Yes."

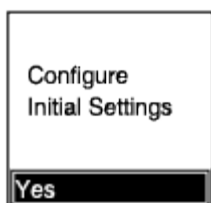

- 2 Press ▲ or ▼ to select the display language, and then press ►.

You can select from the following languages:

Deutsch (German), English, Español (Spanish), Français (French), Italiano (Italian), Русский (Russian), Türkçe (Turkish), 한국어 (Korean), 简体中文 (Simplified Chinese), 繁體中文 (Traditional Chinese).

- 3 Set the current date and time.

Press ▲ or ▼ to set an item, and then press ►.

Repeat the actions to set all items.

To move the focus backward or forward, press ◀◀ or ▶▶. You can also press BACK/HOME to move the focus to the previous item.

When you are finished with the last item, press ► to apply the settings to the clock.

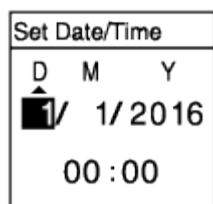

- 4 Press ▲ or ▼ to select “Next,” and then press ►.

The setting window for turning the beep sound on or off is displayed.

- 5 Press ▲ or ▼ to select “ON” or “OFF” to turn on or off the beep sound, and then press ►.

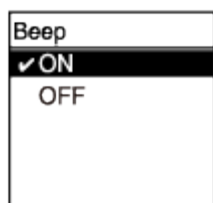

When the initial settings finish, the completion message and then the HOME menu appears.

Note

- The default date display format depends on the country or region of your purchase.
- The clock may tell the time either in 12-Hour format with “AM” or “PM” or in the 24-Hour format, depending on the selected clock display format (Time Display) on the Settings menu. In addition, the default clock display format depends on the country or region of your purchase.
- The number of language options you can select and the default setting differ depending on the country or region of your purchase.

Hint

- You can change the clock setting and the beep sound setting at any time later by selecting “ Settings” - “Common Settings” from the HOME menu.
- Once you have removed the batteries from the compartment and inserted them back in or you have replaced the batteries with new ones, the Set Date/Time screen appears on the display window. On this screen, you see the date and time of the last operation you made with your IC recorder before you removed the batteries. Be sure to change the date and time to the current ones.
- When you are finished with the initial settings, placing your IC recorder into the HOLD state displays the current date and time on the display window.

Related Topic

- [Setting the clock \(Date&Time\)](#)
- [Turning the beep sound on or off \(Beep\)](#)
- [While the HOME menu is displayed](#)

IC Recorder
ICD-PX470

Placing the IC recorder into the HOLD state (HOLD)

You can disable all the buttons (HOLD) on your IC recorder in order to prevent unintentional operations while you carry around the IC recorder.

- 1 Slide the HOLD•POWER switch to “HOLD.”

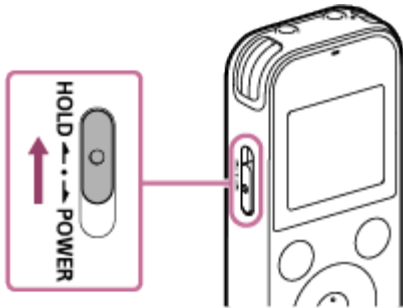

While the IC recorder is turned on, sliding the HOLD•POWER switch to “HOLD” displays “HOLD” and the current time for approximately 3 seconds on the display window, indicating that all the buttons are disabled.



Note

- Placing your IC recorder into the HOLD state disables all the buttons. Be sure to release it from the HOLD state before you use the IC recorder again.
- The clock may tell the time either in 12-Hour format with “AM” or “PM” or in the 24-Hour format, depending on the selected clock display format (Time Display) on the Settings menu. In addition, the default clock display format depends on the country or region of your purchase.

Related Topic

- [Releasing the IC recorder from the HOLD state](#)

IC Recorder
ICD-PX470

Releasing the IC recorder from the HOLD state

When all the buttons on your IC recorder are disabled, pressing any button displays “HOLD... Slide HOLD Switch to Activate.” on the display window.



Release the IC recorder from the HOLD state before you use it.

- 1 Slide the HOLD•POWER switch to the center dot.

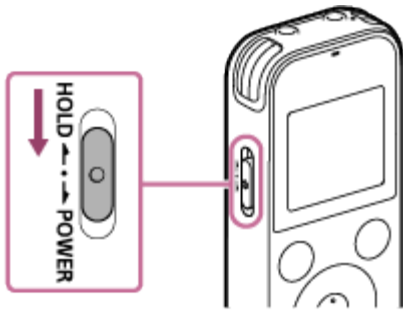

Related Topic

- [Placing the IC recorder into the HOLD state \(HOLD\)](#)

IC Recorder
ICD-PX470

Maintaining the moderate volume level (European models only)

The IC recorder limits the maximum volume to allow you to listen to the sound at a moderate volume level when using the headphones. When you try to adjust the volume to a level that exceeds the specified level, the “Check The Volume Level” message appears.

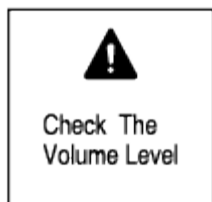

IC Recorder
ICD-PX470

Recording with the built-in microphones

The following describes the basic recording steps with the selected sensitivity level of the built-in microphones and recording mode.

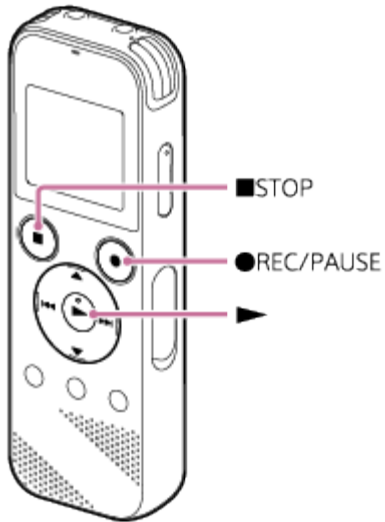

Note

- If you accidentally touch your IC recorder or let an object come in contact with it while recording is in progress, rustling or scratching noises may be recorded.

Hint

- Before you start recording, we recommend you first make a trial recording or monitor the recording. For instructions on monitoring the recording, see [Monitoring the recording audio](#).
- Recorded files are stored in "FOLDER01" under "Recorded Files" by default. To change the file storage destination folder for recorded file, see [Changing the file storage destination folder](#).

- 1 Select "🎙️ Record" on the HOME menu, and then press ►.

The recording standby screen appears on the display window.



- 2 Turn your IC recorder so that its built-in microphones (①) point in the direction of the target sound source.

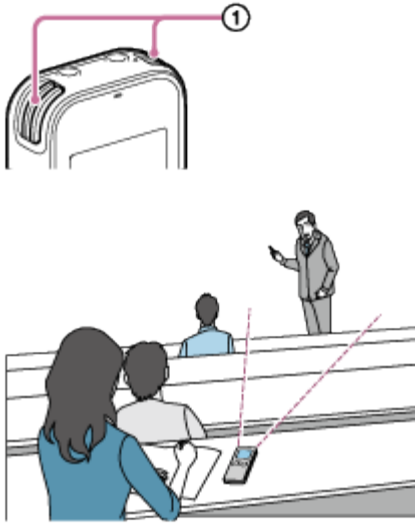

- 3 Press ● REC/PAUSE.

The Record screen appears to indicate that recording has started, and the operation indicator (②) lights in red.

If you press and hold ● REC/PAUSE, the IC recorder will pause. It will not start recording.

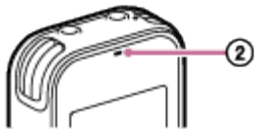

While recording is in progress, the recording level guide (③) is displayed on the Record screen.

As illustrated below, three or four black squares (■) on the recording level guide indicate the optimum recording volume levels for the sound source. Adjust the orientation of the built-in microphones, the distance from the sound source, or the sensitivity setting of the microphones to keep the volume within the optimum range.

For more information about the recording level guide, see [About the recording level guide](#).

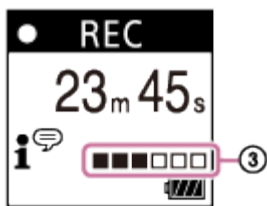

- 4 Press ■ STOP to stop recording.

The “Saving...” message and then the recording standby screen appear.

Now you can press ► to play the file you have just recorded.

Note

- While the “Saving...” message is on the display window, your IC recorder is saving the file to the memory storage. If the IC recorder is running on AC power, do not disconnect the USB AC adaptor (not supplied) to avoid data corruption.

Hint

- You can still press ● REC/PAUSE to start recording while playback is in progress or a menu is on the display window.
- You can still press ● REC/PAUSE to pause the ongoing recording while a menu is on the display window.
- Recorded files are named as “(recording date)_(recording time).(file format)” (e.g. 161010_0706.mp3).
- While playback is in progress or on standby, you can press and hold ● REC/PAUSE to make your IC recorder pause for recording. This helps you adjust the recording volume level without recording unnecessary audio data.

Related Topic

- [Additional operations available during recording](#)

IC Recorder
ICD-PX470

About the recording level guide

While recording is in progress, the recording level guide (①) appears on the Record screen.

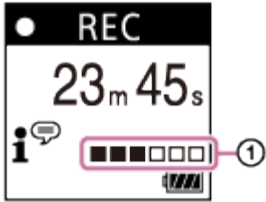

As illustrated above, three or four black squares (■) on the recording level guide indicate the optimum recording volume levels for the sound source. Adjust the orientation of the built-in microphones, the distance from the sound source, or the sensitivity setting of the microphones to keep the volume within the optimum range. See [Selecting the sensitivity level of the built-in microphones \(Built-In Mic Sensitivity\)](#) for selecting the microphone sensitivity level.

Hint

- When the input sound volume is low, it is recommended you move your IC recorder closer to the sound source or increase the microphone sensitivity level.
- While playback is in progress or on standby, you can press and hold ● REC/PAUSE to make your IC recorder pause for recording. This helps you adjust the recording volume level without recording unnecessary audio data.

Related Topic

- [Recording with the built-in microphones](#)

IC Recorder
ICD-PX470

Monitoring the recording audio

You can monitor the ongoing recording by connecting headphones (not supplied) to the ♪ (headphones) jack.

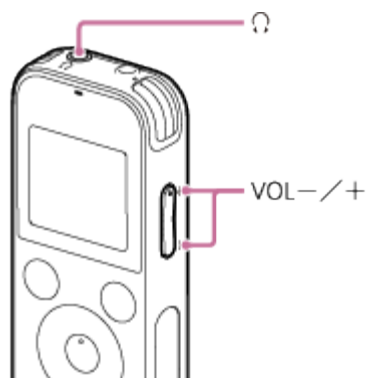

1 Connect headphones (not supplied) to the ♪ (headphones) jack.

2 Press VOL -/+ to adjust the monitoring volume.

Changing the monitoring volume does not affect the recording volume.

Related Topic

- [Recording with the built-in microphones](#)

IC Recorder
ICD-PX470

Additional operations available during recording

You can perform the following operations during recording.

To pause a recording

Press **●** REC/PAUSE.

While a recording is paused, the operation indicator flashes in red and **●|| PAUSE** appears on the display window. If you leave the recording paused for 1 hour, it will stop automatically.

To restart the recording from a pause

Press **●** REC/PAUSE again.

The recording restarts from the paused point. (To completely stop recording after you paused the recording, press **■** STOP.)

To review the ongoing recording from the beginning

While recording is on standby, press **▶**.

The recording stops and plays from the beginning.

Related Topic

- [Recording with the built-in microphones](#)

IC Recorder
ICD-PX470

Changing the file storage destination folder

By default, the recorded files via the built-in microphones are stored in "FOLDER01" under "📁 Recorded Files." You can change this storage folder setting by following the steps below:

- 1 Select "🔧 Settings" - "Recording Settings" - "Recording Folder" from the HOME menu, and then press ▶.



The Memory Selection screen appears.

- 2 Press ▲ or ▼ to select "Built-In Memory" or "SD Card," and then press ▶.

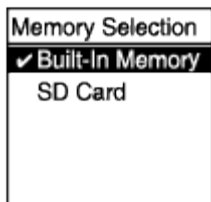

- 3 Press ▲ or ▼ to select the desired folder, and then press ▶.

Hint

- For instructions on creating a new folder, see [Creating a folder](#).

IC Recorder
ICD-PX470

Selecting a recording scene for an individual situation

According to a particular recording situation, you can change some recording settings, including the recording mode and the sensitivity level of the built-in microphones, at once by selecting one of the recording scenes (Scene Select).

- 1 While recording is on standby, select "Scene Select" on the OPTION menu, and then press ►.

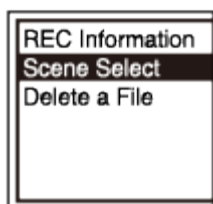

- 2 Press ▲ or ▼ to select a scene you want, and then press ►.



Description of menu items

You can select one of the following items:

Scene Select Off:

Available for the situation where no recording scene selection is required.

Auto Voice Rec:

Suitable for recording human voices in general (default setting).

Meeting:

Suitable for recording human voices in large spaces, including conference rooms.

Lecture:

Suitable for recording seminars and lectures.

Voice Notes:

Suitable for speaking into the built-in microphones to record voice notes.

Interview:

Suitable for recording human voices from a distance of 1 to 2 meters (40 to 80 inches), such as interviews and small meetings.



Soft Music:

Suitable for recording live music from a distance of 1 to 2 meters (40 to 80 inches), such as chorus or musical instrument lessons.



Loud Music:

Suitable for recording live loud music, such as band performances.

Related Topic

- [Default settings for the recording scenes of the Scene Select function](#)
- [List of the Settings menu items](#)

IC Recorder
ICD-PX470

Selecting the recording function (Focused/Wide)

Select “Focused” or “Wide” according to your recording scene or purpose.

- 1 Select “ Settings” - “Recording Settings” - “Focused/Wide” from the HOME menu, and then press **▶**.
- 2 Press **▲** or **▼** to select the desired recording setting, and then press **▶**.

“Focused” recording function

The “Focused” recording function intensifies sounds from the direction in which the built-in microphones point by minimizing other sounds from the left and the right of your IC recorder. This function is suitable for recording lectures and seminars held in a large hall as well as for recording interviews because it achieves high directivity and allows you to focus on recording what you aiming at.

Selecting “Lecture” for the Scene Select function turns on the “Focused” recording function.



“Wide” recording function

The “Wide” recording function controls the sound panning between left and right to minimize voice overlapping and add more stereo feelings. This function is suitable for note taking from recordings of meetings because it gives you a better idea of where meeting participants are seated and who is speaking.

Selecting “Meeting” for the Scene Select function turns on the “Wide” recording function.

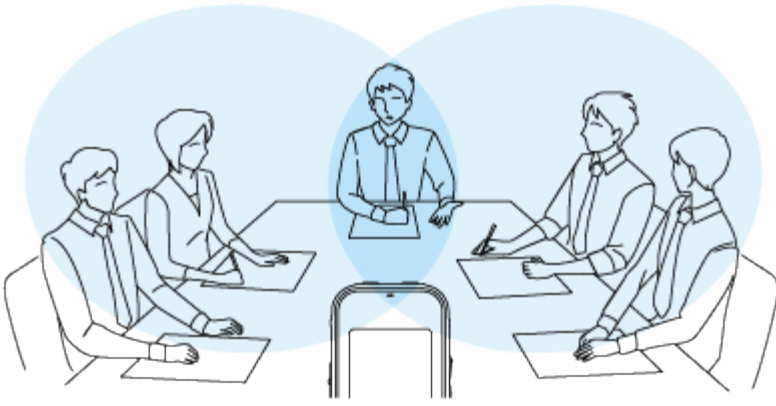

Description of menu items

You can select one of the following items:

OFF:

Turns off the “Focused/Wide” recording function (default setting).

Focused:

Turns on the “Focused” recording function.

Wide:

Turns on the “Wide” recording function.

Note

- The “Focused/Wide” recording function is turned off while:
 - “For Music” or “Auto” under “For Voice” is selected for the sensitivity level of the built-in microphones of your IC recorder.
 - “MIC IN” or “Audio IN” is selected for “Ext. Input Setting.”

Related Topic

- [Selecting a recording scene for an individual situation](#)

IC Recorder
ICD-PX470

Tips for better recording

Recording at a meeting

Place your IC recorder close to speakers of the meeting. You can reduce noise (vibrations from the desk, etc.) by placing the IC recorder on a soft cloth, such as a handkerchief.

For recording a meeting, it is suitable to select “Auto Voice Rec” or “Meeting” of the Scene Select function.



Recording a lecture/presentation

Place your IC recorder so that its built-in microphones point in the direction of the lecturer/presenter.

For recording a lecture/presentation, it is suitable to select “Lecture” of the Scene Select function.

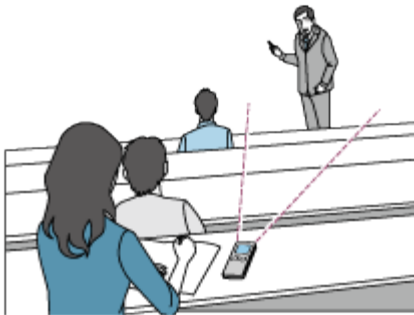

Recording a voice note

When you speak into the built-in microphones, hold your IC recorder slightly off to the side of your mouth so that the built-in microphones will not pick up breathing noises.

For recording a voice note, it is suitable to select “Auto Voice Rec” or “Voice Notes” of the Scene Select function.

Note

- While you are holding your IC recorder, make sure that the built-in microphones will not pick up rustling noises.



Recording an interview

Place your IC recorder so that the built-in microphones point in the direction of the interviewee.
For recording an interview, it is suitable to select “Auto Voice Rec” or “Interview” of the Scene Select function.



Recording a soft music performance

With your IC recorder, you can record immersive stereo sound by placing it close to musical instruments. However, if you place the IC recorder on the piano to record a piano performance, for example, it will record vibration noise from the piano as well as the performance. Be sure to place the IC recorder beside the piano to avoid recording undesirable noise.

With Sound Organizer 2, you can use recorded music performance files to make your own music CD as well.

For recording a soft music performance, it is suitable to select “Soft Music” of the Scene Select function.

If the audio of a recorded file is distorted, you can select “ Settings” - “Recording Settings” - “Built-In Mic Sensitivity” - “For Music” - “Low(Music)” from the HOME menu to reduce distortion for the next recording.



Recording a loud music performance

Place your IC recorder from a distance of 1 to 2 meters (40 to 80 inches) from performers.
For recording a loud music performance, it is suitable to select “Loud Music” of the Scene Select function.

- If the audio of a recorded file is distorted, place the IC recorder further away to record performances.







Related Topic



- [Selecting a recording scene for an individual situation](#)
- [Reducing noise during recording \(Recording Filter\)](#)
- [Selecting the sensitivity level of the built-in microphones \(Built-In Mic Sensitivity\)](#)

IC Recorder
ICD-PX470

Default settings for the recording scenes of the Scene Select function

By default, the settings for the recording scenes of the Scene Select function are as follows:

	 Auto Voice Rec	 Meeting	 Lecture	 Voice Notes
REC Mode	MP3 192kbps	MP3 192kbps	MP3 192kbps	MP3 128kbps
Built-In Mic Sensitivity	For Voice - Auto	For Voice - Medium	For Voice - Medium	For Voice - Low
Focused/Wide	OFF	Wide	Focused	OFF
Ext. Input Setting(MIC IN)	For Voice - Auto	For Voice - Medium	For Voice - Medium	For Voice - Low
VOR	OFF	OFF	OFF	OFF
Recording Filter	LCF(Low Cut)	NCF(Noise Cut)	NCF(Noise Cut)	LCF(Low Cut)

	 Interview	 Soft Music	 Loud Music	OFF
REC Mode	MP3 128kbps	MP3 192kbps	MP3 192kbps	MP3 192kbps
Built-In Mic Sensitivity	For Voice - Medium	For Music - Medium(Music)	For Music - Low(Music)	For Voice - Medium
Focused/Wide	OFF	OFF	OFF	OFF
Ext. Input Setting(MIC IN)	For Voice - Medium	For Music - Medium(Music)	For Music - Low(Music)	For Voice - Medium
VOR	OFF	OFF	OFF	OFF
Recording Filter	NCF(Noise Cut)	OFF	OFF	OFF



Related Topic

- [Selecting a recording scene for an individual situation](#)



IC Recorder
ICD-PX470

Recording automatically in response to the input sound volume – the VOR function

You can set your IC recorder to automatically start when the input sound volume reaches the predefined level, and pause when the volume decreases below the level.

- 1 Select "  Settings" - "Recording Settings" - "VOR" from the HOME menu, and then press .



- 2 Press  or  to select "ON," and then press .
- "VOR" is set to "OFF" by default.

- 3 Press  REC/PAUSE.

 appears on the display window.

When the input sound volume decreases below the predefined level, flashing  appears and the recording pauses. When the volume reaches the level once again, the recording restarts.

Note

- The VOR function is affected by the ambient sound conditions. Select the sensitivity level of the built-in microphones suitable to your ambient sound conditions. For instructions on selecting the sensitivity level, see [Selecting the sensitivity level of the built-in microphones \(Built-In Mic Sensitivity\)](#).
If the selected sensitivity level does not work as you expected or when you want make an important recording, follow the above steps to set "VOR" to "OFF."

Hint

- To cancel the VOR function setup process, set “VOR” to “OFF” in step 2.

Related Topic

- [Recording audio from an external device](#)

4-595-548-31(1) Copyright 2016 Sony Corporation

IC Recorder
ICD-PX470

Recording with an external microphone

You can connect an external microphone to your IC recorder and use it for recording.

- 1 While no IC recorder operations are in progress, connect an external microphone (①) to the  (microphone) jack.

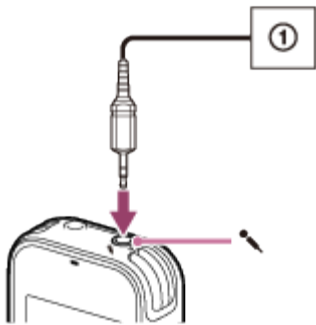

“Ext. Input Setting” appears on the display window. If not, select “ Settings” - “Recording Settings” - “Ext. Input Setting” from the HOME menu.

- 2 Press ▲ or ▼ to select “MIC IN,” and then press ►.

- 3 Press ● REC/PAUSE to start recording.

The built-in microphones are disabled and audio via the external microphone is recorded.

If the input audio volume is not loud enough, select “ Settings” - “Recording Settings” - “Ext. Input Setting” - “MIC IN” - “Sensitivity setting” from the HOME menu to change the sensitivity level of the external microphone.

When a plug in power type microphone is connected, power is automatically supplied to the microphone from the IC recorder.

Related Topic

- [Selecting the audio input type and the sensitivity level of the external microphone \(Ext. Input Setting\)](#)
- [Selecting the sensitivity level of the built-in microphones \(Built-In Mic Sensitivity\)](#)

IC Recorder
ICD-PX470

Recording audio from an external device

You can make music files without using a computer by recording audio/music from the device (a radio cassette recorder, a tape recorder, TV, etc.) connected to your IC recorder.

Hint

- If the input audio volume is not loud enough, connect the audio connection cable from your IC recorder to the headphones jack (stereo mini-jack) on the external device, adjust the volume of the external device while checking on the recording level guide on the IC recorder's display window.

- 1 While no IC recorder operations are in progress, connect an external device (①) to the  (microphone) jack on the IC recorder.

Use an audio connection cable to connect the audio output jack (stereo mini-jack) on the external device and the  (microphone) jack on the IC recorder.

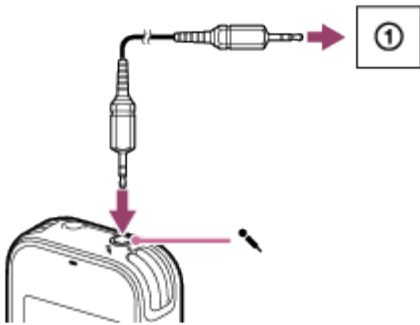

“Ext. Input Setting” appears on the display window. If not, select “ Settings” - “Recording Settings” - “Ext. Input Setting” from the HOME menu.

- 2 Press ▲ or ▼ to select “Audio IN,” and then press ►.

- 3 Press ● REC/PAUSE to start recording.

● REC appears on the display window and the IC recorder starts recording audio from the connected external device.

- 4 Start playback on the connected external device.

Related Topic

- [Recording the playback audio of the IC recorder on an external device](#)
- [Selecting the audio input type and the sensitivity level of the external microphone \(Ext. Input Setting\)](#)

IC Recorder
ICD-PX470

Recording the playback audio of the IC recorder on an external device

You can connect an external device to your IC recorder and record playback audio from the IC recorder. Before you start recording, we recommend you make a trial recording first.

1 Connect one end of an audio connection cable to the  (headphones) jack on the IC recorder and the other end to the external input jack on the external device.

2 Press  on the IC recorder and the record button on the external device simultaneously to start playback on the IC recorder and recording on the external device.

The playback audio from the IC recorder is recorded on the external device.

3 Press  STOP on the IC recorder and the stop button on the external device.

Hint

- When connecting an external device to your IC recorder, use an audio connecting cable without resistance.

IC Recorder
ICD-PX470

Playing a file

You can select a file from the HOME menu for playback.

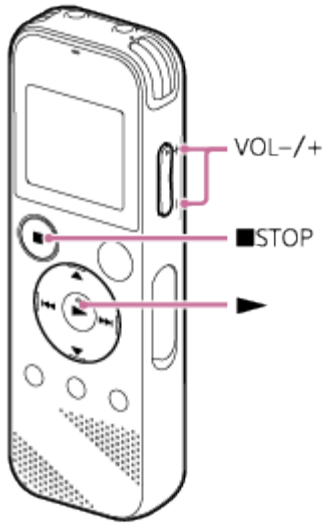

1 Select "🎵 Music" or "📁 Recorded Files" on the HOME menu, and then press ►.

2 Search and select a file.

For instructions on searching a file, see [Selecting a file](#).

3 Press ►.

Playback starts.

4 Press VOL -/+ to adjust the playback volume.

Note

- For the customers in Europe only:
When you try to adjust the volume to a level that exceeds the specified level, the “Check The Volume Level” message appears.

Hint

- To stop playback, press ■ STOP.
- When you stop recording and the recording standby screen is on the display window, you can press ► to play the file you have just recorded.

Related Topic

- [Additional operations available during playback](#)
- [Playing music files on the IC recorder that were copied from a computer](#)

IC Recorder
ICD-PX470

Selecting a file

You can select a file from the HOME menu for playback or editing.

1 Select “🎵 Music” or “📁 Recorded Files” on the HOME menu, and then press ▶.

2 Select a file search category.

Press ▲ or ▼ to select one of the following file search categories, and then press ▶.

🎵 Music: “All Songs,” “Albums,” “Artists,” and “Folders”

📁 Recorded Files: “Latest Recording,” “Search by REC Date,” “Search by REC Scene,” and “Folders”

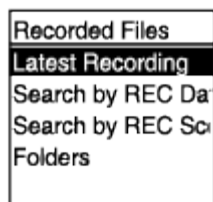

Selecting “Folders” as the file search category displays the Memory Selection screen. Select either “Built-In Memory” or “SD Card” as the memory storage.

If you insert the microSD card that has previously been used in another IC recorder, “SD Card(Other Models)” may appear in addition to “SD Card.”

3 Select a list or folder from the search results, and then select a file.

Press ▲ or ▼ to select a list or folder, and then select the file.

Hint

- By default, your IC recorder has the “FOLDER01” folder created under “📁 Recorded Files.”

IC Recorder
ICD-PX470

Additional operations available during playback

You can perform the following operations while playback is in progress .

To stop at the current position

Press  STOP.

To resume playback from that point, press .

To go back to the beginning of the current file

Press  once.

If track marks are added and the Easy Search function is turned off, the previous track mark point toward the beginning of the file is located.

To go back to previous files

Press  repeatedly.

To skip to the next file

Press  once.

If track marks are added and the Easy Search function is turned off, the next track mark point toward the end of the file is located.

To skip to the succeeding files

Press  repeatedly.

Related Topic

- [Adding a track mark](#)
- [Locating the desired playback point quickly \(Easy Search\)](#)

IC Recorder
ICD-PX470

Reducing noise in the playback audio to make human voices sound clearer – the Clear Voice function

The Clear Voice function reduces ambient noises to make human voices distinctive. You will hear human voices more clearly in the playback audio.

- 1 While playback is on standby or in progress, select "Clear Voice" on the OPTION menu, and then press ►.

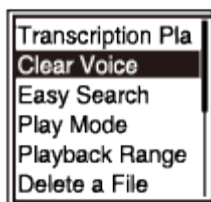

- 2 Press ▲ or ▼ to select "Clear Voice 1" or "Clear Voice 2," and then press ►.

Description of menu items

You can select one of the following items:

OFF:

Turns off the Clear Voice function (default setting).

Clear Voice 1:

Reduces ambient noises and adjust loudness of human voices to the optimum level to make human voices sound more clearly.

Clear Voice 2:

Reduces ambient noises further than "Clear Voice 1" to make human voices sound much more clearly.

Note

- While playback with the built-in speaker or playback of the files in "🎵 Music" is in progress, the Clear Voice function does not work.

IC Recorder
ICD-PX470

Using the transcription playback mode

In the transcription playback mode, you can fast-forward or fast-rewind to search for a particular point as well as use the DPC (Digital Pitch Control) function to slow down the playback speed. This is useful when you want to transcribe a recorded file of a meeting, etc.

- 1 While playback is on standby, select "Transcription Playback Mode" on the OPTION menu, and then press ►.

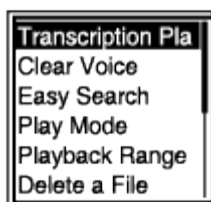

- 2 Press ► to start playback.

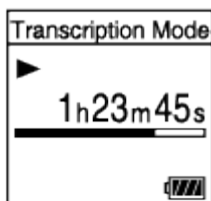

You can use the following functions while your IC recorder is in the transcription playback mode.

- DPC: You can change the playback speed to help you understand what you are listening more easily. Press ▲ DPC (Digital Pitch Control) to display the DPC setting screen. Press ◀◀/▶▶ to adjust the playback speed, press ▲ or ▼ to select "ON," and then press ►.
- Easy Search: You can quickly search the file for the desired point by pressing ◀◀/▶▶.
- Cue/Review: You can search the file for the desired point by pressing and holding ◀◀/▶▶.

Note

- When your IC recorder is placed in the transcription playback mode, you cannot:
— use the playback mode.

- turn on the A-B repeat playback function.
- turn on the button-hold repeat playback function.

Hint

- To stop playback, press ■ STOP.
- To exit the transcription playback mode, select “End Transcription Playback Mode” on the OPTION menu while your IC recorder is in the transcription playback mode or playback is on standby.
- To listen to other files, press BACK/HOME to display the file list, and then select a file.

Related Topic

- [Adjusting the playback speed – the DPC \(Digital Pitch Control\) function](#)
- [Locating the desired playback point quickly \(Easy Search\)](#)

IC Recorder
ICD-PX470

Adjusting the playback speed – the DPC (Digital Pitch Control) function

You can adjust the playback speed in a range from 0.25 times to 3.00 times. Changing the playback speed does not affect the playback audio. Files will play in natural tones, thanks to digital processing.

You can also change the playback speed while your IC recorder is in the “Transcription Playback Mode.”

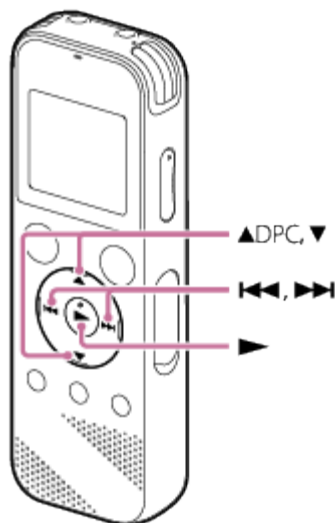

- 1 While playback is on standby or in progress, press ▲ DPC (Digital Pitch Control).
The DPC setting screen is displayed.

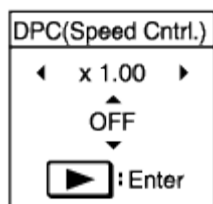

- 2 Press ◀◀ or ▶▶ to adjust the playback speed.

The speed decreases by 0.05 times (from x 0.25 to x 1.00).

The speed increases by 0.10 times (from x 1.00 to x 3.00).

When you press and hold either button, you can change the speed continuously.

The playback speed is set to “x 1.00” by default.

- 3 Press ▲ or ▼ to select “ON.”

4 Press ► to set the playback speed.

Hint

- To resume the normal playback speed, select “OFF” in step 3.

Related Topic

- [Using the transcription playback mode](#)

IC Recorder
ICD-PX470

Selecting the playback mode

You can select the playback mode that suits your needs.

- 1 While playback is on standby or in progress, select "Play Mode" on the OPTION menu, and then press **▶**.

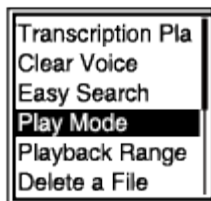

- 2 Press **▲** or **▼** to select a playback mode, and then press **▶**.

Description of menu items

You can select one of the following items:

Normal:

Plays the files in the specified range one by one.



Repeat:

Plays the files in the specified range repeatedly.



1 File Play:

Plays the current file to the end and stops.



1 File Repeat:

Plays the current file repeatedly.



Shuffle:

Plays the files in the specified range at random.



Shuffle Repeat:

Plays the files in the specified range repeatedly at random.

Related Topic

- [Specifying a segment of a file to play repeatedly \(A-B repeat\)](#)
- [Continually playing the current file \(Button-hold repeat playback\)](#)

IC Recorder
ICD-PX470

Specifying a segment of a file to play repeatedly (A-B repeat)

You can specify the starting point A and the finishing point B in a file to play the segment between the specified points repeatedly.

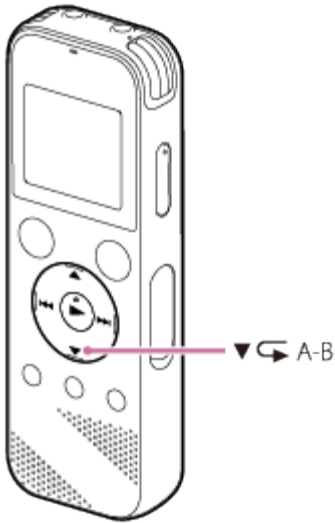

- 1 While playback is on standby or in progress, press ▼ ↻ A-B to specify the starting point A.
“A-B B?” is displayed.
- 2 Press ▼ ↻ A-B again to specify the finishing point B.
“↻ A-B” is displayed and the specified segment plays repeatedly.

Note

- If you specify the starting point A and then specify the same point as the finishing point B while playback is on standby, the specified starting point A will be cancelled.
- You cannot turn on the button-hold repeat playback function while the A-B repeat playback function is active.

Hint

- To turn off the A-B repeat playback function and resume the normal playback, press ▼ ↻ A-B again.
- To change the segment specified for the A-B repeat playback function, resume the normal playback and then repeat steps 1 and 2 once again.

Related Topic

- [Selecting the playback mode](#)
- [Continually playing the current file \(Button-hold repeat playback\)](#)

IC Recorder
ICD-PX470

Continually playing the current file (Button-hold repeat playback)

You can repeat playback of the file you are currently playing with a simple operation.



1 While playback is in progress, press and hold .

 appears on the playback screen and the current file plays repeatedly.

Note

- You cannot turn on the button-hold repeat playback function while the A-B repeat playback function is active.

Hint

- To turn off the button-hold repeat playback function and resume the normal playback, press  or  STOP.
- You can turn on the button-hold repeat playback function while your IC recorder is in a particular playback mode.



Related Topic

- [Specifying a segment of a file to play repeatedly \(A-B repeat\)](#)

IC Recorder
ICD-PX470

Specifying the playback range in the stored file list

You can specify the playback range in the playback file list. The contents in the playback range vary depending on the selected file search category for the recorded files or music.

- 1 Select “ Recorded Files” or “ Music” on the HOME menu, and then press **▶**.
- 2 Press **▲** or **▼** to select a file search category, and then press **▶**.
- 3 Select a file you want to play, and then press **▶**.
- 4 While playback is on standby or in progress, select “Playback Range” on the OPTION menu, and then press **▶**.

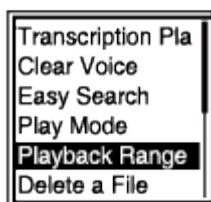



- 5 Press **▲** or **▼** select “All Range” or “Selected Range,” and then press **▶**.

Descriptions of menu items

You can select one of the following items:

All Range:

Plays all files that belong to the file search category you selected for “ Recorded Files” or “ Music.”

 Selected Range:

Plays all files that are contained in the folder (recording date, recording scene, artist name, album title, etc.), including the current playing file.

Selecting “ Selected Range” displays the folder icon on the playback screen.

Related Topic

- [Selecting a file](#)

4-595-548-31(1) Copyright 2016 Sony Corporation

IC Recorder
ICD-PX470

Listening to sound with better quality

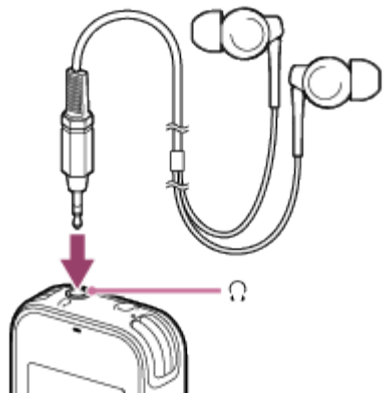

- Use headphones:
Connect headphones (not supplied) to the Ω (headphones) jack. This disables the built-in speaker.
- Use external speakers:
Connect active speakers (not supplied) to the Ω (headphones) jack.

IC Recorder
ICD-PX470

Searching forward/backward (Cue/Review)

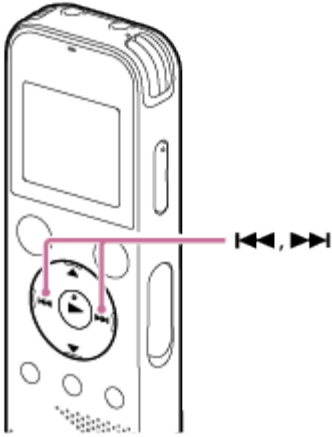

- To search forward (Cue):
While playback is on standby or in progress, press and hold **▶▶** and release it at the point you want to resume playback.
- To search backward (Review):
While playback is on standby or in progress, press and hold **◀◀** and release it at the point you want to resume playback.

Forward or backward search begins at a slow speed, which helps you check the file word by word. If you keep holding either button, forward or backward search will continue at a faster speed.

Related Topic

- [Locating the desired playback point quickly \(Easy Search\)](#)

IC Recorder
ICD-PX470

Locating the desired playback point quickly (Easy Search)

The Easy Search function helps you quickly locate the point from which you want to play.

- 1 While playback is on standby or in progress, select "Easy Search" on the OPTION menu, and then press ►.

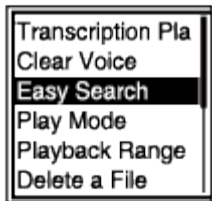

- 2 Press ▲ or ▼ to select "ON," and then press ►.

Description of menu items

You can select one of the following items:

ON:

Turns on the Easy Search function. While playback is in progress, pressing ►► fast-forwards by 10 seconds and pressing ◀◀ fast-rewinds by 3 seconds.

OFF:

Turns off the Easy Search function (default setting).

IC Recorder
ICD-PX470

Deleting a file

You can select a file and delete it.

Note

- Once you have deleted a file, you will not be able to restore it.

- 1 Select a file you want to delete.
- 2 Select "Delete a File" on the OPTION menu, and then press ►.



"Delete?" appears and the specified file plays for confirmation.

- 3 Press ▲ or ▼ to select "Yes," and then press ►.

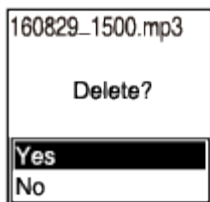

The "Please Wait" message appears on the display window and the selected file will be deleted.

Note

- You cannot delete a protected file. To delete a protected file, remove protection from the file first, then delete the file. For instructions on protecting

a file, see [Protecting a file](#).

Hint

- To cancel the deleting process, select “No” in step 3, and then press ►.
- To delete a part of a file, first divide the file into two files, select the file you want to delete, and proceed with step 2 and step 3. For instructions on dividing a file, see [Dividing a file at the current playback point](#).

Related Topic

- [Selecting a file](#)
- [Deleting all files in the searched folder or list](#)
- [Deleting a folder](#)

IC Recorder
ICD-PX470

Deleting all files in the searched folder or list

You can select a folder or list from the file search results and delete all of the contained files.

- 1 Select “🎵Music” or “📁Recorded Files” on the HOME menu, and then press ▶.
- 2 Press ▲ or ▼ to select a file search category, and then press ▶.
- 3 Press ▲ or ▼ to select the folder or list containing the files you want to delete, and then press ▶.
- 4 Select “Delete All Files” or “Delete All in List” on the OPTION menu, and then press ▶.



“Delete All Files in This Folder?” or “Delete All Files in This List?” appears on the display window.

- 5 Press ▲ or ▼ to select “Yes,” and then press ▶.

The “Please Wait” message appears on the display window and all files in the selected folder or list will be deleted.

Note

- You cannot delete a protected file. To delete a protected file, remove protection from the file first, then delete the file. For instructions on protecting a file, see [Protecting a file](#).

Hint

- To cancel the deleting process, select “No” in step 5, and then press ►.

Related Topic

- [Deleting a file](#)
- [Deleting a folder](#)

4-595-548-31(1) Copyright 2016 Sony Corporation

IC Recorder
ICD-PX470

Deleting a folder

You can select a folder and delete it.

- 1 Select "🎵 Music" or "📁 Recorded Files" on the HOME menu, and then press ►.
- 2 Press ▲ or ▼ to select "Folders" and the memory storage, and then press ►.
- 3 Press ▲ or ▼ to select the desired folder.
- 4 Select "Delete Folder" on the OPTION menu, and then press ►.



"Delete Folder?" appears on the display window.

- 5 Press ▲ or ▼ to select "Yes," and then press ►.

The selected folder is deleted.

If the selected folder contains files, "Delete All Files in This Folder?" appears. Press ▲ or ▼ to select "Yes," and then press ► to delete the folder and its files. If the selected folder contains sub-folders, however, you cannot delete the sub-folders and their files.

Note

- If the selected folder contains protected files, an attempt to delete the folder only deletes unprotected files, leaving the folder and the protected files undeleted. Remove protection from such files first, then delete the folder. For instructions on protecting a file, see [Protecting a file](#).

Hint

- To cancel the deleting process, select “No” in step 5, and then press ►.
- If you delete the current file storage destination folder, “Switch Recording Folder” appears on the display window and “FOLDER01” (default destination folder) is assigned as the new file storage destination folder.
- If you delete all of the file storage destination folders, “No Folders - Creating New Recording Folder” appears on the display window and “FOLDER01” is automatically created.

Related Topic

- [Deleting a file](#)
- [Deleting all files in the searched folder or list](#)

IC Recorder
ICD-PX470

Moving a file to a different folder

You can select a file and move it to another folder.

1 Select the file you want to move.

2 While playback is on standby, select "Move/Copy File" on the OPTION menu, and then press ►.

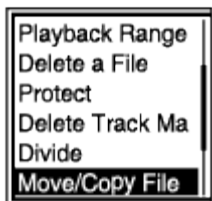

3 Press ▲ or ▼ to select "Move to Built-In Memory" or "Move to SD Card," and then press ►.

4 Press ▲ or ▼ to select the destination folder, and then press ►.

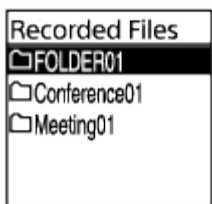

The "Please Wait" message appears and the file will be moved from the source folder to the destination folder.

Note

- You cannot move a protected file. To move the file, remove the protection first, and then move the file. For instructions on removing protection, see [Protecting a file](#).
- You cannot move music files.

Related Topic

- [Selecting a file](#)
- [Copying a file to a different folder](#)

4-595-548-31(1) Copyright 2016 Sony Corporation

IC Recorder
ICD-PX470

Copying a file to a different folder

You can select a file and copy it to another folder, which is useful in making a backup copy.

1 Select the file you want to copy.

2 While playback is on standby, select "Move/Copy File" on the OPTION menu, and then press ►.

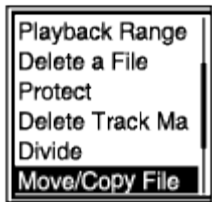

3 Press ▲ or ▼ to select "Copy to Built-In Memory" or "Copy to SD Card," and then press ►.

4 Press ▲ or ▼ to select the destination folder, and then press ►.

The "Please Wait" message appears and the file will be copied from the source folder to the destination folder with the same name.

Note

- You cannot copy a protected file. To copy the file, you must remove the protection first. For instructions on removing protection, see [Protecting a file](#).
- You cannot copy music files.

Related Topic

- [Selecting a file](#)
- [Moving a file to a different folder](#)

IC Recorder
ICD-PX470

Creating a folder

Recorded files are stored in "FOLDER01" under "📁 Recorded Files" by default. You can create a new folder and change this default folder to it.

- 1 Select "🔧 Settings" - "Recording Settings" - "Create Folder" from the HOME menu, and then press ▶.

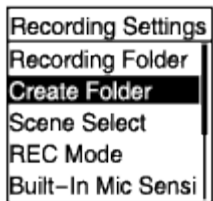

- 2 Select "Built-In Memory" or "SD Card" on the Memory Selection screen, and then press ▶.

- 3 Select ▲ or ▼ to select a folder name from the template, and then press ▶.

A new folder is created.

Note

- You cannot create a folder in "🎵 Music."

IC Recorder
ICD-PX470

Adding a track mark

You can add a track mark at a point where you want to divide a file later or you want to locate during playback. You can add a maximum of 98 track marks to a single file.

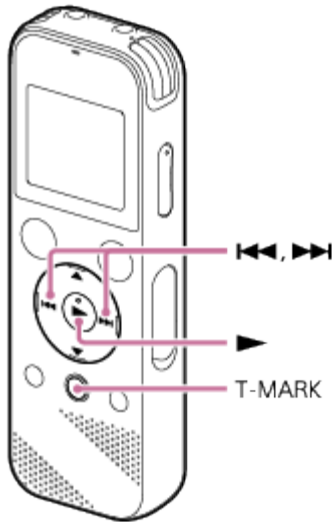

- 1 While recording is in progress or paused, or while playback is in progress or on standby, press T-MARK at the point you want to add a track mark.

The  (track mark) indicator flashes three times, and a track mark is added.

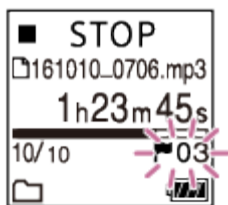

Note

- You cannot add track marks to a protected file. To add track marks to a protected file, remove protection from the file first, then add track marks. For instructions on protecting a file, see [Protecting a file](#).

Hint

- To locate a track mark and start playback at the track mark, press ◀◀ or ▶▶ while playback is on standby or in progress. While playback is on standby, wait for the  (Track mark) indicator to flash once, and then press ▶ to start playback.
- You can add track marks while your IC recorder is in the transcription playback mode.
- With the HOME menu on the display window, you can still add a track mark by pressing T-MARK while:
 - recording is in progress or paused.
 - playback is in progress or on standby.

Related Topic

- [Adding track marks automatically](#)
- [Deleting a track mark](#)

IC Recorder
ICD-PX470

Adding track marks automatically

You can add track marks automatically at specified intervals while you are recording.

- 1 Select "  Settings" - "Recording Settings" - "Auto Track Marks" from the HOME menu, and then press **▶**.

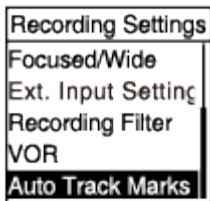

- 2 Press **▲** or **▼** to select "Interval," and then press **▶**.

- 3 Press **▲** or **▼** to select the interval length and then press **▶**.

You can select from "5min," "10min," "15min," or "30min."
The Auto Track Marks function is turned on.

- 4 Press and hold BACK/HOME to return to the HOME menu.

Hint

- To cancel the Auto Track Marks function setup process, select "OFF" in step 2.
- While the Auto Track Marks function is turned on, you can still press T-MARK during recording to add a track mark at any point.

Related Topic

- [Adding a track mark](#)
- [Deleting a track mark](#)

IC Recorder
ICD-PX470

Deleting a track mark

You can delete the closest track mark before the point where you stopped playback.

- 1 Select the file from which you want to delete track marks.
- 2 Play the file and stop at a point after the track mark you want to delete.
- 3 Select "Delete Track Marks" - "This Track Mark" from the OPTION menu, and then press ►.

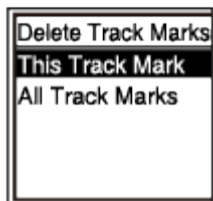

"Delete Track Mark?" appears on the display window.

- 4 Press ▲ or ▼ to select "Yes," and then press ►.

The "Please Wait" message appears in the display window and the selected track mark will be deleted.

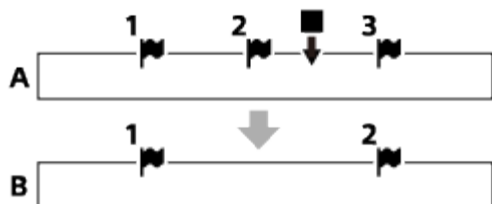

A. Before deleting a track mark: ■ indicates the point where you stopped playback.

B. After deleting a track mark: The closest track mark before the point where you stopped playback will be deleted.

- You cannot delete track marks from a protected file. To delete track marks from a protected file, remove protection from the file first, then delete the track marks. For instructions on protecting a file, see [Protecting a file](#).
- While recording is on standby, you cannot delete track marks with the OPTION menu. Use the HOME menu to select the file containing the track mark that you want to delete.

Hint

- To cancel the deleting process, select “No” in step 4, and then press ►.

Related Topic

- [Selecting a file](#)
- [Deleting all the track marks in the selected file at one time](#)

IC Recorder
ICD-PX470

Deleting all the track marks in the selected file at one time

You can delete all the track marks of the selected file.

1 Select the file from which you want to delete the track marks.

2 Select "Delete Track Marks" - "All Track Marks" from the OPTION menu, and then press ►.

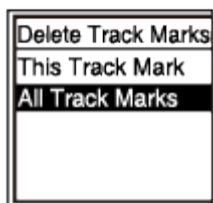

"Delete All Track Marks?" appears on the display window.

3 Press ▲ or ▼ to select "Yes," and then press ►.

The "Please Wait" message appears and all the track marks will be deleted at one time.

Note

- You cannot delete track marks from a protected file. To delete track marks from a protected file, remove protection from the file first, then delete the track marks. For instructions on protecting a file, see [Protecting a file](#).
- You cannot delete track marks while recording is on standby. Use the HOME menu to select the file containing the track mark that you want to delete.

Hint

- To cancel the deleting process, select "No" in step 3, and then press ►.

- [Selecting a file](#)
- [Deleting a track mark](#)

4-595-548-31(1) Copyright 2016 Sony Corporation

IC Recorder
ICD-PX470

Dividing a file at the current playback point

You can divide a single file into two files. Dividing a file helps you quickly locate the point from which you want to play in a long recording file, such as a meeting recording. You can further divide either of the divided files.

- 1 Select the file that you want to divide, and then play the file and stop at a point where you want to divide the file.
- 2 Select "Divide" - "Current Position" from the OPTION menu, and then press ►.

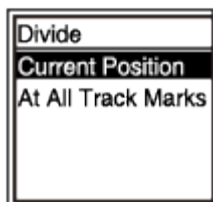

"Divide at Current Stop Position?" appears on the display window.

- 3 Press ▲ or ▼ to select "Yes," and then press ►.

The "Please Wait" message appears, and the divided files will be suffixed with a sequential number ("_01" for the first part, and "_02" for the second part).

A	File 1	File 2	File 3
	↓	▲	
B	File 1	File 2_01	File 2_02
		File 3	

- A. Before dividing a file: ▲ indicates where you divided the file.
 B. After dividing a file: A suffix made up of a sequential number is added to the file name of the divided files.

Note

- You cannot divide a protected file. To divide a protected file, remove protection from the file first, then divide the file. For instructions on protecting a file, see [Protecting a file](#).

Hint

- To cancel the dividing process, select “No” in step 3, and then press ►.

Related Topic

- [Selecting a file](#)
- [Dividing a file at all the track mark points](#)

IC Recorder
ICD-PX470

Dividing a file at all the track mark points

You can divide a file at all the track mark points.

1 Select the file that you want to divide, and then play the file and stop at any point.

2 While playback is on standby, select "Divide" - "At All Track Marks" from the OPTION menu, and then press ►.

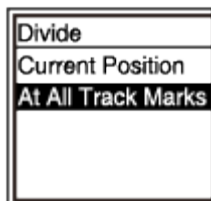

"Divide at All Track Marks?" appears on the display window.

3 Press ▲ or ▼ to select "Yes," and then press ►.

The "Please Wait" message appears and the file will be divided at all the track mark points, deleting all the track marks. The divided files will be suffixed with a sequential number ("_01," "_02," and so on).

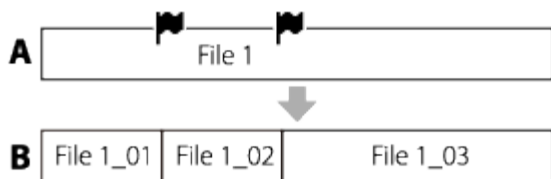

A. Before dividing a file: 🚩 indicates a track mark point.

B. After erasing track marks: A file is divided at all the track mark points, and the divided files will be suffixed with a sequential number ("_01," "_02," and so on).

Note

- You cannot divide a protected file. To divide a protected file, remove protection from the file first, then divide the file. For instructions on protecting a file, see [Protecting a file](#).

- Track marks located near the beginning and end of the source file may not be used for dividing and remain in the divided files.

Hint

- To cancel the dividing process, select “No” in step 3, and then press ►.

Related Topic

- [Selecting a file](#)
- [Dividing a file at the current playback point](#)

IC Recorder
ICD-PX470

Protecting a file

To prevent a file from being accidentally deleted or edited, you can protect an important file. A protected file is marked with the  (protect) indicator and is regarded as a read-only file that you cannot delete or edit.

1 Select the file that you want to protect.

2 While playback is on standby, select “Protect” on the OPTION menu, and then press .



“Protected” appears on the display window and the file is protected. When you play the protected file, the  (protect) indicator appears on the playback screen.

Hint

- To remove protection from a file, select the protected file, and then select “Do Not Protect” in step 2.

Related Topic

- [Selecting a file](#)

IC Recorder
ICD-PX470

List of the Settings menu items

The following lists the  Settings menu items on the HOME menu.

Recording Settings

- Recording Folder:
[Changing the file storage destination folder](#)
- Create Folder:
[Creating a folder](#)
- Scene Select:
[Selecting a recording scene for an individual situation](#)
- REC Mode:
[Selecting the recording mode \(REC Mode\)](#)
- Built-In Mic Sensitivity:
[Selecting the sensitivity level of the built-in microphones \(Built-In Mic Sensitivity\)](#)
- Focused/Wide:
[Selecting the recording function \(Focused/Wide\)](#)
- Ext. Input Setting:
[Selecting the audio input type and the sensitivity level of the external microphone \(Ext. Input Setting\)](#)
- Recording Filter:
[Reducing noise during recording \(Recording Filter\)](#)
- VOR:
[Recording automatically in response to the input sound volume – the VOR function](#)
- Auto Track Marks:
[Adding track marks automatically](#)

Playback Settings

- Clear Voice:

Reducing noise in the playback audio to make human voices sound clearer – the Clear Voice function

- Easy Search:

[Locating the desired playback point quickly \(Easy Search\)](#)

- Play Mode:

[Selecting the playback mode](#)

- Playback Range:

[Specifying the playback range in the stored file list](#)

Common Settings

- LED:

[Turning the operation indicator on or off \(LED\)](#)

- Beep:

[Turning the beep sound on or off \(Beep\)](#)

- Language:

[Selecting the display language \(Language\)](#)

- Date&Time:

[Setting the clock \(Date&Time\)](#)

- Time Display:

[Selecting the clock display format \(Time Display\)](#)

- Date Display Format:

[Selecting the date display format \(Date Display Format\)](#)

- Auto Power Off:

[Setting the time period before the IC recorder automatically turns off \(Auto Power Off\)](#)

- Reset/Format:

[Resetting all menu settings to the default ones \(Reset All Settings\)](#)

[Formatting the memory \(Format Built-In Memory/Format SD Card\)](#)

- Available Rec. Time:

[Checking the remaining recording time \(Available Rec. Time\)](#)

- System Information:

[Checking the information about the IC recorder \(System Information\)](#)

- Using the HOME menu

4-595-548-31(1) Copyright 2016 Sony Corporation

IC Recorder
ICD-PX470

Selecting the recording mode (REC Mode)

You can set the recording mode for audio recordings. Set this menu item before you start recording.

- 1 Select "  Settings" - "Recording Settings" - "REC Mode" from the HOME menu, and then press ►.



- 2 Select the desired recording mode, and then press ►.
- 3 Press and hold BACK/HOME to return to the HOME menu.
To return to the screen before you displayed the HOME menu, press ■ STOP.

Description of menu items

You can select one of the following items:

LPCM 44.1kHz/16bit:

LPCM (not compressed) in stereo high-quality recording mode

MP3 192kbps:

MP3 (compressed) in stereo standard-quality recording mode (default setting)

MP3 128kbps:

MP3 (compressed) in long play stereo recording mode

MP3 48kbps(MONO):

MP3 (compressed) in monaural standard recording mode







IC Recorder
ICD-PX470

Selecting the sensitivity level of the built-in microphones (Built-In Mic Sensitivity)

You can select the sensitivity level of the built-in microphones. Set this menu item before you start recording.

- 1 Select "  Settings" - "Recording Settings" - "Built-In Mic Sensitivity" from the HOME menu, and then press .



- 2 Press  or  to select "For Voice" or "For Music," and then press .
- 3 Press  or  to select the desired level of the microphone sensitivity, and then press .
- 4 Press and hold BACK/HOME to return to the HOME menu.
To return to the screen before you displayed the HOME menu, press  STOP.

Description of menu items

You can select one of the following items:

For Voice:

You can select one of the following sensitivity levels for recording voices.

- Auto: An appropriate sensitivity level is automatically selected according to the input human voices (default setting).
- High: Suitable for recording distant or soft human voices in large spaces, including conference rooms.
- Medium: Suitable for recording small meetings or interviews.
- Low: Suitable for speaking into the built-in microphones to record voice notes or recording nearby or loud human voices.

For Music:

You can select one of the following sensitivity levels for recording music.

- High(Music): Suitable for recording small-group chorus performances and distant musical instrument sounds.
- Medium(Music): Suitable for recording live music from a distance of 1 to 2 meters (40 to 80 inches), such as chorus or musical instrument lessons.
- Low(Music): Suitable for recording live loud music, such as band performances.

Note

- While recording audio from an external device is in progress, the Built-In Mic Sensitivity function is turned off.



Related Topic

- [Selecting the audio input type and the sensitivity level of the external microphone \(Ext. Input Setting\)](#)



IC Recorder
ICD-PX470

Reducing noise during recording (Recording Filter)

With the Recording Filter function, you can reduce noise in the recordings.

- 1 Select "  Settings" - "Recording Settings" - "Recording Filter" from the HOME menu, and then press .



- 2 Press  or  to select "NCF(Noise Cut)" or "LCF(Low Cut)," and then press .

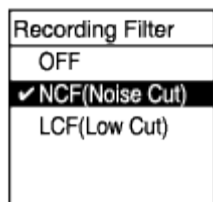

- 3 Press and hold BACK/HOME to return to the HOME menu.

To return to the screen before you displayed the HOME menu, press  STOP.

Description of menu items

You can select one of the following items:

OFF:

Turns off the Recording Filter function.

NCF(Noise Cut):

Cuts high-frequency sounds except for human voices as well as low-frequency sounds.

LCF(Low Cut):

Cuts low-frequency sounds, including noise from projectors and roaring wind sounds (default setting).

Note

- While “Audio IN” is selected for “Ext. Input Setting” is in progress, the Recording Filter function does not work.
- If one of the recording levels for music is selected for the sensitivity level of the built-in microphones, the recording filter “NCF(Noise Cut)” is turned off because it is optimized for voice recording.

Hint

- To cancel the Recording Filter function setup process, select “OFF” in step 2.



Related Topic

- [Selecting the audio input type and the sensitivity level of the external microphone \(Ext. Input Setting\)](#)

IC Recorder
ICD-PX470



Selecting the audio input type and the sensitivity level of the external microphone (Ext. Input Setting)

You can select the audio input type ("MIC IN" or "Audio IN") of the  (microphone) jack and the sensitivity level of the external microphone.

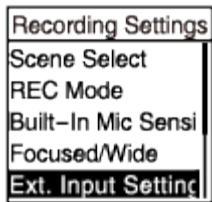
- 1 Select "  Settings" - "Recording Settings" - "Ext. Input Setting" from the HOME menu, and then press .





If an external microphone is not connected to the  (microphone) jack, "Only Activated When External Input Used" appears.



- 2 Press  or  to select the desired audio input type, and then press .

- To select the audio input type and leave the sensitivity level of the external microphone as it is:



Select "MIC IN" or "Audio IN."



MIC IN: Select this audio input type when an external microphone is connected to the  (microphone) jack.

Audio IN: Select this audio input type when an external device other than a microphone is connected to the  (microphone) jack.

When you are finished with the selection, press . Pressing  switches the audio input type and displays the Recording Settings menu. Proceed to step 5.

- To select the audio input type and the sensitivity level of the external microphone:

Select "Sensitivity setting" under "MIC IN," and then press . Pressing  displays the Sensitivity setting screen. Proceed to step 3.

- 3 Press  or  to select "For Voice" or "For Music," and then press .

- 4 Press  or  to select the desired sensitivity level, and then press .

5 Press and hold BACK/HOME to return to the HOME menu.

To return to the screen before you displayed the HOME menu, press ■ STOP.

Description of menu items on the Sensitivity setting screen

You can select one of the following items:

For Voice:

You can select one of the following sensitivity levels for recording voices.

- Auto: An appropriate sensitivity level is automatically selected according to the input human voices (default setting).
- High: Suitable for recording distant or soft human voices in large spaces, including conference rooms.
- Medium: Suitable for recording small meetings or interviews.
- Low: Suitable for speaking into the built-in microphones to record voice notes or recording nearby or loud human voices.

For Music:

You can select one of the following sensitivity levels for recording music.

- High(Music): Suitable for recording small-group chorus performances and distant musical instrument sounds.
- Medium(Music): Suitable for recording live music from a distance of 1 to 2 meters (40 to 80 inches), such as chorus or musical instrument lessons.
- Low(Music): Suitable for recording live loud music, such as band performances.



Hint

- The recording volume level may vary depending on the external microphone. Check on the recording level guide and change the microphone sensitivity level.





IC Recorder
ICD-PX470

Turning the operation indicator on or off (LED)

You can set the operation indicator to turn on or off during IC recorder operations.

- 1 Select "  Settings" - "Common Settings" - "LED" from the HOME menu, and then press .



- 2 Press  or  to select "ON" or "OFF," and then press .
- 3 Press and hold BACK/HOME to return to the HOME menu.
To return to the screen before you displayed the HOME menu, press  STOP.

Description of menu items

You can select one of the following items:

ON:

The operation indicator lights or flashes according to IC recorder operations (default setting).

OFF:

The operation indicator stays unlit during IC recorder operations.

IC Recorder
ICD-PX470

Selecting the display language (Language)

You can select the language to be used for messages, menus, folder names, etc.

- 1 Select "  Settings" - "Common Settings" - "Language" from the HOME menu and then press ►.

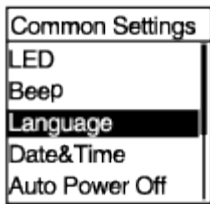

- 2 Press ▲ or ▼ to select the language that you want to use, and then press ►.

You can select the language from Deutsch (German), English, Español (Spanish), Français (French), Italiano (Italian), Русский (Russian), Türkçe (Turkish), 한국어 (Korean), 简体中文 (Simplified Chinese), 繁體中文 (Traditional Chinese).

- 3 Press and hold BACK/HOME to return to the HOME menu.

To return to the screen before you displayed the HOME menu, press ■ STOP.



Note

- The number of language options you can select and the default setting differ depending on the country or region of your purchase.

IC Recorder
ICD-PX470

Setting the clock (Date&Time)

You can set the clock of your IC recorder. Be sure to set it before you start recording.

- 1 Select "  Settings" - "Common Settings" - "Date&Time" - "Set Date/Time" from the HOME menu, and then press .

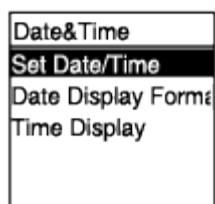

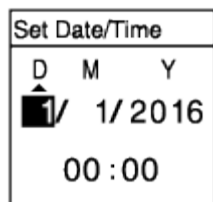

- 2 Set the current date and time.



Press  or  to set an item, and then press .

Repeat the actions to set all items.

To move the focus backward or forward, press  or . You can also press BACK/HOME to move the focus to the previous item.

When you are finished with the last item, press  to apply the settings to the clock.

- 3 Press and hold BACK/HOME to return to the HOME menu.

To display the current time, place your IC recorder into the HOLD state.

Note

- Once you have removed the batteries from the compartment and inserted them back in or you have replaced the batteries with new ones, the Set

Date/Time screen appears on the display widow. On this screen, you see the date and time of the last operation you made with your IC recorder before you removed the batteries. Be sure to change the date and time to the current ones.

- The clock may tell the time either in 12-Hour format with “AM” or “PM” or in the 24-Hour format, depending on the selected clock display format (Time Display) on the Settings menu. In addition, the default clock display format depends on the country or region of your purchase.
- The default date display format depends on the country or region of your purchase.

Related Topic

- [Placing the IC recorder into the HOLD state \(HOLD\)](#)





IC Recorder
ICD-PX470

Selecting the date display format (Date Display Format)

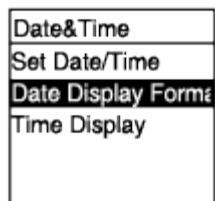
You can select the date display format to suit your preference.

- 1 Select "  Settings" - "Common Settings" - "Date&Time" - "Date Display Format" from the HOME menu, and then press .



- 2 Press  or  to select the desired format, and then press .
- 3 Press and hold BACK/HOME to return to the HOME menu.
To return to the screen before you displayed the HOME menu, press  STOP.

Description of menu items

You can select one of the following items:

YYYY/MM/DD:

The date appears in the year/month/date format.

MM/DD/YYYY:

The date appears in the month/date/year format.

DD/MM/YYYY:

The date appears in the date/month/year format.



Note

- The default setting differs depending on the area you purchased your IC recorder.





IC Recorder
ICD-PX470

Selecting the clock display format (Time Display)

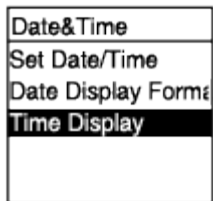
You can select either the 12-Hour or 24-Hour format.

- 1 Select "  Settings" - "Common Settings" - "Date&Time" - "Time Display" from the HOME menu, and then press .



- 2 Press  or  to select the desired format, and then press .
- 3 Press and hold BACK/HOME to return to the HOME menu.
To return to the screen before you displayed the HOME menu, press  STOP.

Description of menu items

You can select one of the following items:

12-Hour:

12:00AM = midnight, 12:00PM = noon

24-Hour:

00:00 = midnight, 12:00 = noon

Note

- The default setting differs depending on the country or region of your purchase.

IC Recorder
ICD-PX470

Turning the beep sound on or off (Beep)

You can turn the operation beep sound on or off.

- 1 Select "  Settings" - "Common Settings" - "Beep" from the HOME menu, and then press ►.

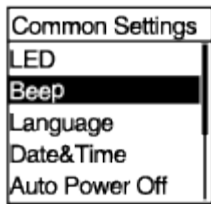

- 2 Press ▲ or ▼ to select "ON" or "OFF," and then press ►.
- 3 Press and hold BACK/HOME to return to the HOME menu.
To return to the screen before you displayed the HOME menu, press ■ STOP.

Description of menu items

You can select one of the following items:

ON:

A beep will sound to indicate that an operation is accepted or an error occurs (default setting).

OFF:

No beeps will sound.

IC Recorder
ICD-PX470

Setting the time period before the IC recorder automatically turns off (Auto Power Off)

You can set your IC recorder to automatically turn off if it is left unused for the specified period time.

- 1 Select "  Settings" - "Common Settings" - "Auto Power Off" from the HOME menu, and then press **▶**.

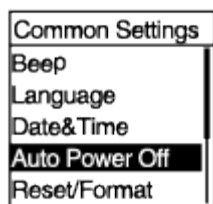

- 2 Press **▲** or **▼** to select the desired time period, and then press **▶**.

- 3 Press and hold BACK/HOME to return to the HOME menu.

To return to the screen before you displayed the HOME menu, press **■** STOP.

Description of menu items

You can select one of the following items:

OFF:

Your IC recorder will not turn off automatically.

5min:

Your IC recorder will turn off in approx. 5 minutes.

10min:

Your IC recorder will turn off in approx. 10 minutes (default setting).

30min:

Your IC recorder will turn off in approx. 30 minutes.

60min:



Your IC recorder will turn off in approx. 60 minutes.

IC Recorder
ICD-PX470

Resetting all menu settings to the default ones (Reset All Settings)



You can reset all menu settings to the default ones except for the following:

- Clock settings (Date&Time)
- Display language settings (Language)

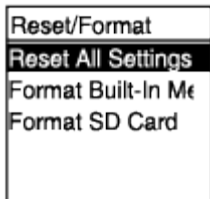
- 1 While recording or playback is on standby, select "  Settings" - "Common Settings" - "Reset/Format" - "Reset All Settings" from the HOME menu, and then press .



"Default Value?" appears on the display window.

- 2 Press  or  to select "Yes," and then press .

The "Please Wait" message appears and all menu settings will be reset to the default ones.

- 3 Press and hold BACK/HOME to return to the HOME menu.

To return to the screen before you displayed the HOME menu, press  STOP.

Hint

- To cancel the resetting process, select "No" in step 2.

IC Recorder
ICD-PX470

Formatting the memory (Format Built-In Memory/Format SD Card)

You can format either the built-in memory of your IC card or the microSD card. Formatting the built-in memory will delete all of the stored data and restore the original folder structure at your purchase.

- 1 While recording or playback is on standby, select "  Settings" - "Common Settings" - "Reset/Format" - "Format Built-In Memory" or "Format SD Card" from the HOME menu, and then press **▶**.

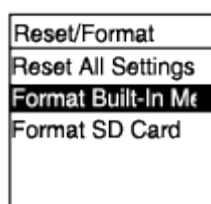

"Delete All Data?" appears.

- 2 Press **▲** or **▼** to select "Yes," and then press **▶**.

The "Please Wait" message appears and the selected memory will be formatted.

- 3 Press and hold BACK/HOME to return to the HOME menu.

To return to the screen before you displayed the HOME menu, press **■** STOP.

Note

- Be sure to use your IC recorder, not a computer, to format the microSD card that you intend to use on the IC recorder.
- Be aware that formatting the built-in memory will delete all of the stored data, including protected files and Sound Organizer 2, and you will not be able to restore anything after the formatting process.

Hint

- To cancel the formatting process, select "No" in step 2.

IC Recorder
ICD-PX470

Checking the remaining recording time (Available Rec. Time)

You can display the remaining recording time in hours, minutes, and seconds.

- 1 Select "  Settings" - "Common Settings" - "Available Rec. Time" from the HOME menu, and then press .

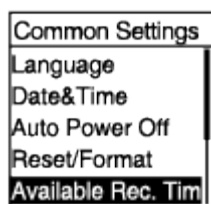

- 2 Press and hold BACK/HOME to return to the HOME menu.
To return to the screen before you displayed the HOME menu, press .

IC Recorder
ICD-PX470

Checking the information about the IC recorder (System Information)

You can display the information about your IC recorder, such as the IC recorder's model name and the software version number.

- 1 Select "  Settings" - "Common Settings" - "System Information" from the HOME menu, and then press ►.



- 2 Press and hold BACK/HOME to return to the HOME menu.
To return to the screen before you displayed the HOME menu, press ■ STOP.

IC Recorder
ICD-PX470

Connecting the IC recorder to a computer

To exchange files between your IC recorder and a computer, connect the IC recorder to the computer.

- 1 Press and hold the USB slide lever on the back of the IC recorder, and then slide it in the direction of the arrow to push out the USB connector. Insert the connector into the USB port on a computer that is up and running.

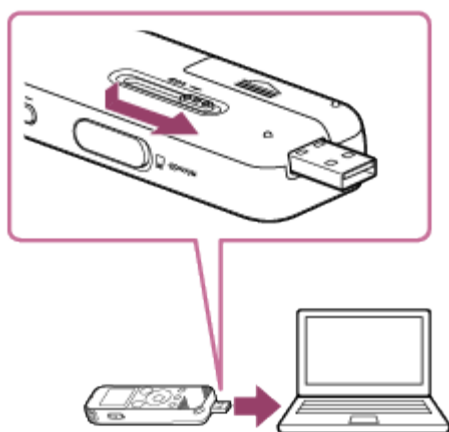

- 2 Make sure the IC recorder is successfully detected by the computer.
 - On the Windows computer, open “Computer” or “PC,” and make sure that “IC RECORDER” or “MEMORY CARD” is detected.
 - On the Mac, make sure that an “IC RECORDER” or “MEMORY CARD” drive appears on the Finder.

The IC recorder is detected by the computer as soon as a connection is made. While the IC recorder is connected to the computer, “Connecting” appears on the display window of the IC recorder.

Related Topic

- [Disconnecting the IC recorder from the computer](#)

IC Recorder
ICD-PX470

Disconnecting the IC recorder from the computer

Be sure to follow the procedure below, otherwise you may not be able to play the files stored on your IC recorder due to data corruption.

1 Make sure that the “Accessing” message is not on the display window.

2 Perform the following operation on the computer.

- On the Windows taskbar at the bottom right of the desktop, click the following icon.



Then, click “Eject IC RECORDER” (Windows 7, Windows 8.1, Windows 10), or “Safely remove USB Mass Storage Device” (Windows Vista). The icon and menu displayed can be different on different operating systems. The icon may not be always displayed on the taskbar depending on your computer settings.

- On the Mac screen, click the removal icon of the “IC RECORDER” that appears on the sidebar of the Finder.

3 Disconnect the IC recorder from the USB port on the computer. Press and hold the USB slide lever, and then slide it in the direction of the arrow to retract the USB connector.

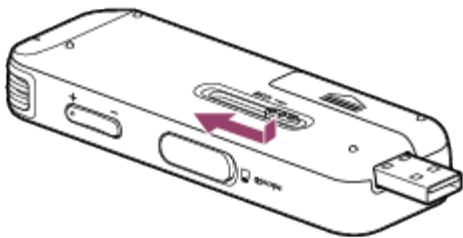

Hint

- For details on disconnecting a USB device from the computer, refer to the operating instructions supplied with the computer.

Related Topic

- [Connecting the IC recorder to a computer](#)

4-595-548-31(1) Copyright 2016 Sony Corporation

IC Recorder
ICD-PX470

Structure of folders and files

You can use a computer to view the structure of folders and files on the built-in memory of your IC recorder or the microSD card. Connect the IC recorder to the computer and use the Explorer (Windows) or the Finder (Mac) to open "IC RECORDER" or "MEMORY CARD." The following illustrates the structure of folders and files:

Built-in memory

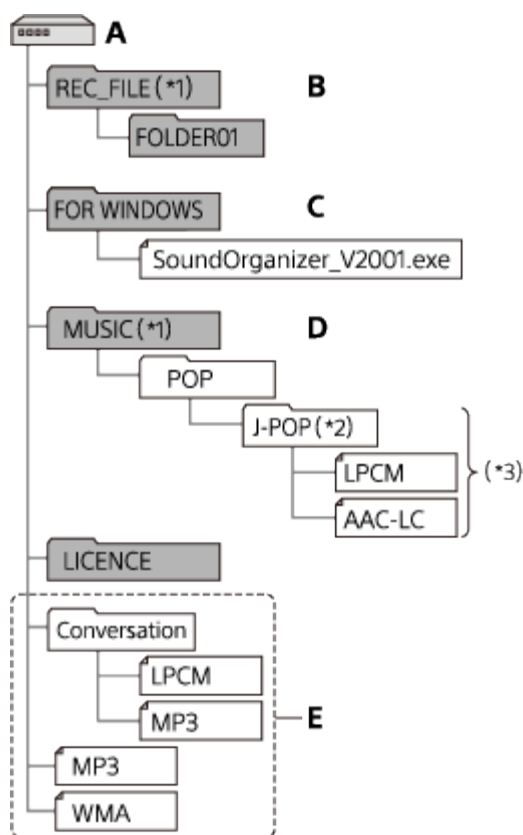

A: IC RECORDER folder

B: Folder for storing files recorded with your IC recorder

C: Folder containing the Sound Organizer 2 installer file

D: Folder for storing files transferred from the computer

E: Your IC recorder is not capable of detecting any folders and files stored at these folder structure levels.

*1 Files stored in the REC_FILE folder appear in "📁 Recorded Files" while those in the MUSIC folder appear in "🎵 Music." When transferring a file, make sure you put it either in the REC_FILE folder or in the MUSIC folder.

*2 The folder containing music files will appear with the same name on your IC recorder. It would help you identify folders if you name the folders with easy-to-remember names. The folder names shown in the above illustration are just examples.

*3 Your IC recorder is capable of detecting up to 8 levels of the transferred music folders.

Hint

- Before transferring music files from the computer to your IC recorder, it would be helpful if you registered the music file information, such as titles

and artist names, on the computer in advance. Then, you can display the music file information or use it for music file search on the IC recorder.

- If a music file has no title assigned, it will appear with its file name on your IC recorder.

microSD card

The microSD card has a different structure of folders and file from the built-in memory of your IC recorder.

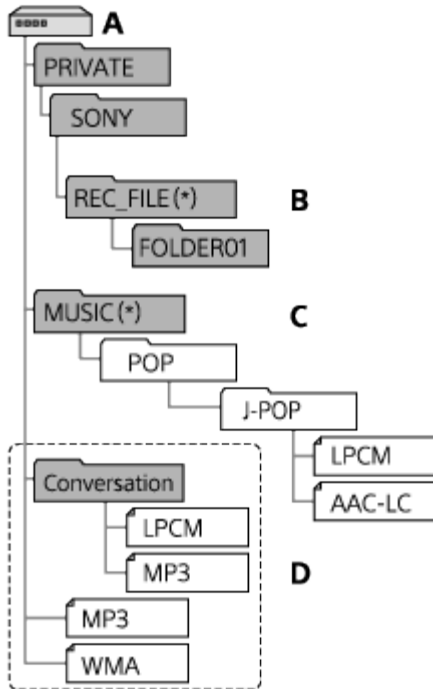



A: microSD card

B: Folder for storing files recorded with your IC recorder

C: Folder for storing files transferred from the computer

D: Your IC recorder is not capable of detecting any folders and files stored at these folder structure levels.

* Files stored in the REC_FILE folder appear in “ Recorded Files” while those in the MUSIC folder appear in “ Music.” When transferring a file, make sure you put it either in the REC_FILE folder or in the MUSIC folder.

IC Recorder
ICD-PX470

Copying files from the IC recorder to a computer

You can copy files and folders from your IC recorder to a computer to store them.



1 Connect the IC recorder to the computer.

2 Copy files or folders you want to transfer to the computer.

Drag and drop the files or folders you want to copy from “IC RECORDER” or “MEMORY CARD” to the local disk on the computer.

3 Disconnect the IC recorder from the computer.

Hint

- To copy a file or folder (drag and drop), click and hold the file or folder (①), drag (②), and then drop (③).

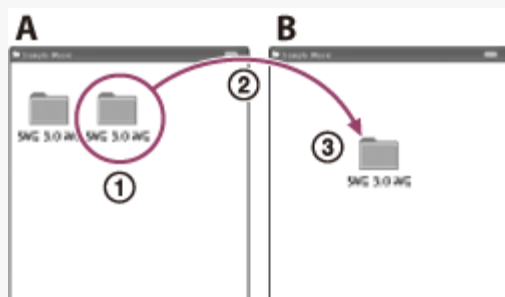

A: IC RECORDER or MEMORY CARD

B: Computer

Related Topic

- [Connecting the IC recorder to a computer](#)
- [Disconnecting the IC recorder from the computer](#)

IC Recorder
ICD-PX470

Copying music files from a computer to the IC recorder

You can copy music and audio files (LPCM(.wav) / MP3(.mp3) / WMA(.wma) / AAC-LC(.m4a)) from a computer to your IC recorder by drag and drop.



1 Connect the IC recorder to the computer.

2 Copy the folder containing music files to the IC recorder.

Open the Explorer (Windows) or the Finder (Mac) and drag and drop the folder containing music files to the REC_FILE folder or the MUSIC folder.

Your IC recorder is capable of storing up to 199 files per folder and up to 5,000 folders and files all together in total per memory.

3 Disconnect the IC recorder from the computer.

Related Topic



- [Technical specifications](#)
- [Connecting the IC recorder to a computer](#)
- [Disconnecting the IC recorder from the computer](#)

IC Recorder
ICD-PX470

Playing music files on the IC recorder that were copied from a computer

You can play the music files that you copied from a computer on your IC recorder.

- 1 Select “ Recorded Files” or “ Music” on the HOME menu and press , and then select a file.

You can search “ Recorded Files” for the files that you copied from a computer to the REC_FILE folder; and “ Music” for the files that you copied to the MUSIC folder.

For instructions on selecting a file, see [Selecting a file](#).

- 2 Press  to start playback.

- 3 Press  STOP to stop playback.

Related Topic

- [While playback is in progress](#)
- [Technical specifications](#)

IC Recorder
ICD-PX470

Using the IC recorder as a USB storage device

You can connect your IC recorder to a computer and use it as a USB storage device.

To use the IC recorder as a USB storage device, you need a computer that meets the system requirements. For more information, see [System requirements](#) .

IC Recorder
ICD-PX470

What you can do with Sound Organizer 2 (for Windows only)

You can install Sound Organizer 2 using the installer file (SoundOrganizer_V2001.exe) stored on the built-in memory of your IC recorder.

Sound Organizer 2 allows you to exchange files with the IC recorder or a memory card. You can play songs imported from other media (music CDs, etc.) and audio files (MP3 files, etc.) imported from another computer as well as transfer them to the IC recorder. With Sound Organizer 2, a variety of operations are available for the imported files: playback, editing, conversion to audio files, burning music CDs, and attaching audio files to e-mails.

For detailed instructions on using Sound Organizer 2, refer to the Sound Organizer 2 help.

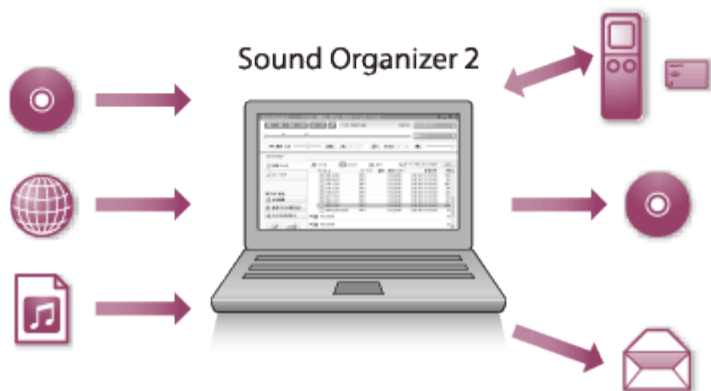

Importing files recorded by the IC recorder

You can import files that you recorded by the IC recorder into Sound Organizer 2. The imported files are saved to the computer.

Importing songs from a music CD

You can import songs from of a music CD into Sound Organizer 2. The imported songs are saved to the computer.

Importing songs on the computer

You can import music and other files stored on the computer into Sound Organizer 2.

Playing files

You can play files imported on Sound Organizer 2.

Changing the file information

You can change the information about songs (titles, artist names, etc.) displayed in the file list.

Dividing files

You can divide one file into multiple files.

Combining files

You can combine multiple files into one file.

Deleting files from the IC recorder

You can delete files stored on your IC recorder.

When you want increase the remaining free space on the IC recorder or you find unnecessary files on the IC recorder, you can directly delete files from Sound Organizer 2.

Transferring files to the IC recorder

You can transfer music and audio files from Sound Organizer 2 to the built-in memory or the microSD card on your IC recorder and enjoy them on the IC recorder.

Burning a music CD

You can select your favorites from the songs imported into Sound Organizer 2 and make your own original music CD.

Other convenient usage

You can start your e-mail software and attach recorded files to an e-mail.

Related Topic

- [Installing Sound Organizer 2 \(for Windows only\)](#)

IC Recorder
ICD-PX470

System requirements for Sound Organizer 2

The following lists the system requirements for Sound Organizer 2.

Operating systems

- Windows 10 Home
- Windows 10 Pro
- Windows 8.1
- Windows 8.1 Pro
- Windows 7 Ultimate
- Windows 7 Professional
- Windows 7 Home Premium
- Windows 7 Home Basic
- Windows 7 Starter
- Windows Vista Ultimate Service Pack 2 or higher
- Windows Vista Business Service Pack 2 or higher
- Windows Vista Home Premium Service Pack 2 or higher
- Windows Vista Home Basic Service Pack 2 or higher

Note

- One of the above operating systems should be pre-installed at shipment. Upgraded operating systems or multi-boot environments are not supported.

IBM PC/AT or compatible

- CPU
Windows Vista/Windows 7/Windows 8.1/Windows 10: Processor of 1.66 GHz or higher
- Memory
Windows Vista: At least 512 MB (In the case of Windows Vista Ultimate/Business/Home Premium, at least 1 GB is recommended.)
Windows 7: At least 1 GB (32 bit version)/At least 2 GB (64 bit version)
Windows 8.1: At least 1 GB (32 bit version)/At least 2 GB (64 bit version)

Windows 10: At least 1 GB (32 bit version)/At least 2 GB (64 bit version)

- Free hard disk space

At least 400 MB is required.

Depending on the version of Windows, more than 400 MB may be used.

Also, free space for handling music data is required.

- Display settings

Screen resolution: 800 × 600 pixels or higher (1,024 × 768 pixels is recommended.)

Screen color: High Color (16 bit) or higher

- USB port

A compatible USB port is required to use devices and media.

Operation via a USB hub is not guaranteed except for models for which operation has been specifically guaranteed.

- Optical disc

To create a music CD, you need a CD-R/RW drive.

IC Recorder
ICD-PX470

Installing Sound Organizer 2 (for Windows only)

Install Sound Organizer 2 on a computer.

Note

- Be sure to install Sound Organizer 2 on the computer that has already Sound Organizer 1.6 installed as well.
- When installing Sound Organizer 2, log in to an account with administrator privileges.
Also, if you are using Windows 7/Windows 8.1 and the [User Account Control] window appears, confirm the contents of the window and then click [Yes] ([Continue] in the case of Windows Vista).
- Installing Sound Organizer 2 adds the Windows Media Format Runtime module. The added Windows Media Format Runtime module will remain if you uninstall Sound Organizer 2. If Windows Media Format Runtime is preinstalled, however, the module may not be installed.
- Uninstalling Sound Organizer 2 does not delete data in the contents storage folders.
- If you have a computer that has multiple Windows operating systems installed, do not install Sound Organizer 2 on each of the operating systems to avoid possible data inconsistencies.

1 Connect your IC recorder to the computer.

2 Go to the [Start] menu, click [Computer], and then double-click [IC RECORDER] - [FOR WINDOWS].

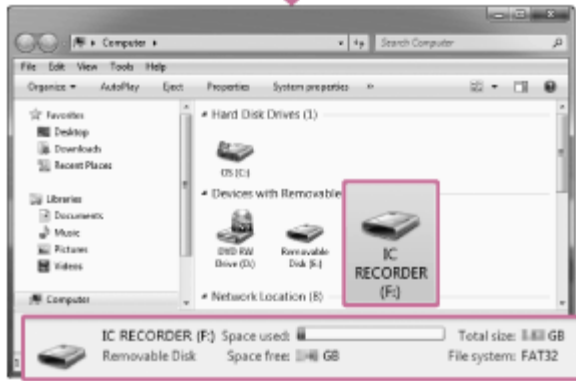

The appearance of the windows on the computer screen varies depending on the version of your operating system. Windows 7 is used as an example in this Help Guide.

- 3 Double-click [SoundOrganizer_V2001] (or [SoundOrganizer_V2001.exe]).



Depending on the version of your operating system, the setup preparation process (file extraction) may start automatically without showing any notice. In such a case, follow the on-screen instructions.

- 4 Make sure that you accept the terms of the license agreement, select [I accept the terms in the license agreement], and then click [Next].

- 5 When the [Setup Type] window appears, select [Standard] or [Custom], and then click [Next].
If you have selected [Custom], follow the on-screen instructions.

- 6 When the [Ready to Install the Program] screen appears, click [Install].
Installation starts.

- 7 When [Sound Organizer 2 has been installed successfully.] window appears, check [Launch Sound Organizer 2 Now], and then click [Finish].

Note

- You may need to restart the computer after you installed Sound Organizer 2.

Related Topic

- [Connecting the IC recorder to a computer](#)

IC Recorder
ICD-PX470

The Sound Organizer 2 window (for Windows only)

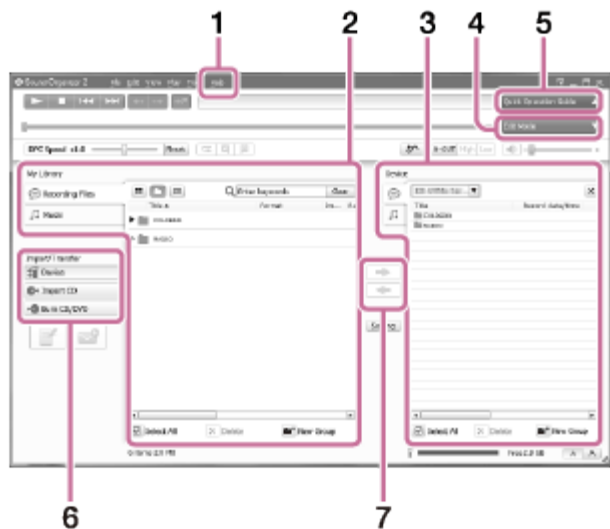

1. Help

Displays the help of Sound Organizer 2. For details on operations, refer to respective help topics.

2. The file list of Sound Organizer 2 (My Library)

Displays a list of files included in My Library of Sound Organizer 2 in accordance with a particular operation.

 **Recording Files:** Displays a list of recording files.

Files that you recorded with your IC recorder appear in this library when they are imported.

 **Music:** Displays a list of music files.

Songs that you imported from music CDs appear in this library.

3. The file list of the IC recorder

Displays the files stored on the connected IC recorder's built-in memory or microSD card.

4. Edit Mode button

Displays the edit area where you can edit a file.

5. Quick Operation Guide button

Displays the Quick Operation Guide to walk you through the basic features of Sound Organizer 2.



6. Sidebar (Import/Transfer)

 **IC Recorder:** Displays the transfer window. A list of files on a connected device appears.

 **Import CD:** Displays the window for importing the contents of a music CD.

 **Burn CD/DVD:** Displays the window for burning a disc.

7. Transfer buttons

-  : Transfers the files from Sound Organizer 2 to the connected IC recorder's built-in memory or microSD card.
-  : Imports the files from the connected IC recorder's built-in memory or microSD card to My Library of Sound Organizer 2.

IC Recorder
ICD-PX470

Compatible memory cards

You can use the following memory cards with your IC recorder.

- microSDHC cards (4 GB to 32 GB)

Due to the specifications of your IC recorder, the file size that you can store on the microSD card for playback is limited as follows:

- LPCM files: less than 4 GB per file
- MP3/WMA/AAC-LC files: less than 1 GB per file

Note

- Your IC recorder does not support microSDXC cards.
- Successful operations with all types of supported microSD cards are not guaranteed.
- If the microSD card is not detected by your IC recorder, remove it from the slot and then insert it back in.
- Keep any liquid and any metal or flammable object away from the microSD card slot to avoid a fire or shock hazard or malfunctions of your IC recorder.
- Before you start recording with a microSD card, we recommend that you copy all the data stored on the memory card to a computer and format the memory card on your IC recorder so it contains no data.

Related Topic

- [Formatting the memory \(Format Built-In Memory/Format SD Card\)](#)

IC Recorder
ICD-PX470

System requirements

To connect your IC recorder to a computer or use it as a USB storage device, the computer must meet the following system requirements.

For using Sound Organizer 2 on the computer, see [System requirements for Sound Organizer 2](#).

Operating systems

- Windows 10 Home
- Windows 10 Pro
- Windows 8.1
- Windows 8.1 Pro
- Windows 7 Ultimate Service Pack 1 or higher
- Windows 7 Professional Service Pack 1 or higher
- Windows 7 Home Premium Service Pack 1 or higher
- Windows 7 Home Basic Service Pack 1 or higher
- Windows 7 Starter Service Pack 1 or higher
- Windows Vista Ultimate Service Pack 2 or higher
- Windows Vista Business Service Pack 2 or higher
- Windows Vista Home Premium Service Pack 2 or higher
- Windows Vista Home Basic Service Pack 2 or higher
- Mac OS X (v10.8-v10.11)

Note

- One of the above operating systems should be pre-installed at shipment. Upgraded operating systems or multi-boot environments are not supported.
- For the latest information on the supported operating systems, visit our support home page (see [Customer support websites](#)).

Hardware requirements

- Port: USB port

- Optical disc drive: To create a music CD, you need a CD-R/RW drive.

Note

The following are not supported:

- Operating systems other than the above
- Any operating system you installed on a homemade computer
- Upgraded operating systems
- Multi-boot environments
- Multi-monitor environments

IC Recorder
ICD-PX470

Technical specifications

Specifications

Capacity (User available capacity) (*1) (*2)	4 GB (approx. 3.20 GB = 3,435,973,837 Byte)
Maximum number of recorded files (for a folder)	199 files
Maximum number of files	5,000 files (including folders)
Frequency range	<ul style="list-style-type: none"> ● LPCM 44.1kHz/16bit: 50 Hz - 20,000 Hz ● MP3 192kbps: 50 Hz - 20,000 Hz ● MP3 128kbps: 50 Hz - 16,000 Hz ● MP3 48kbps(MONO): 50 Hz - 14,000 Hz
Compatible file formats	<p>MP3 (*3) (*4)</p> <ul style="list-style-type: none"> ● Bit rate: 32 kbps - 320 kbps (Supports variable bit rate (VBR)) ● Sampling frequencies: 16/22.05/24/32/44.1/48 kHz ● File extension: .mp3
	<p>WMA (*3) (*5) (*6)</p> <ul style="list-style-type: none"> ● Bit rate: 32 kbps - 192 kbps (Supports variable bit rate (VBR)) ● Sampling frequencies: 44.1 kHz ● File extension: .wma
	<p>AAC-LC (*3) (*6)</p> <ul style="list-style-type: none"> ● Bit rate: 16 kbps - 320 kbps (Supports variable bit rate (VBR)) ● Sampling frequencies: 11.025/12/16/22.05/24/32/44.1/48 kHz ● File extension: .m4a

	<p>LPCM (*3)</p> <ul style="list-style-type: none"> ● Quantization bit rate: 16 bit ● Sampling frequencies: 44.1 kHz ● File extension: .wav
Built-in speaker	Approx. 20 mm (0.79 in.) dia.
Input/Output	<ul style="list-style-type: none"> ● External input jack (minijack, stereo) Input for plug in power, minimum input level 1.0 mV ● Headphone jack (minijack, stereo) Output for 16 Ω impedance headphones ● USB connector (Type-A) High-Speed USB compatible ● Card slot microSD memory card slot
Playback speed control (DPC)	3.00 times - 0.25 times: MP3/WMA/AAC-LC/LPCM
Power output	300 mW
Power requirements	<ul style="list-style-type: none"> ● Two LR03 (size AAA) alkaline batteries (supplied): 3.0 V DC ● Two NH-AAA rechargeable batteries (not supplied): 2.4 V DC
Ambient conditions	<ul style="list-style-type: none"> ● Operating temperature: 5 °C - 35 °C (41 °F - 95 °F) ● Operating humidity: 25% - 75% ● Storage temperature: -10°C - +45°C (14 °F - 113 °F) ● Storage humidity: 25% - 75%
Dimensions (w/h/d) (not incl. projecting parts and controls)	Approx. 38.3 mm × 114.1 mm × 19.3 mm (1.51 in. × 4.50 in. × 0.76 in.) (Width/Height/Depth) (JEITA) (*7)
Mass	Approx. 74 g (2.7 oz) (including two LR03 (size AAA) alkaline batteries, JEITA) (*7)
Supplied accessories	See Operating Instructions supplied with your IC recorder.
Available accessories (*8)	Electret condenser microphone: ECM-CS3, ECM-TL3 Rechargeable battery: NH-AAA-B2KN, NH-AAA-B2GN Battery charger: BCG-34HS2GN, BCG-34HW2GN

-
- *1 Some of the built-in memory is used for file management.
 - *2 Applies when the built-in memory is formatted by the IC recorder.
 - *3 Not all encoders are supported.
 - *4 Playback of the MP3 files recorded by the IC recorder is also supported.
 - *5 WMA Ver.9 is compatible, however, MBR (Multi Bit Rate), Lossless, Professional, and Voice are not supported.
 - *6 Copyright-protected files are not available for playback.
 - *7 Measured value by the standard of JEITA (Japan Electronics and Information Technology Industries Association)
 - *8 Depending on the country or region of your purchase, some of the optional accessories are not available.







Design and specifications are subject to change without notice.

IC Recorder
ICD-PX470







Maximum recording time

The following lists the maximum recording time (*1) (*2) per memory by recording mode (recording scene). The maximum recording time is estimated, provided that all the folders in the memory are used.

Built-in memory

REC Mode (REC Scene) (*3)	Maximum recording time
LPCM 44.1kHz/16bit	5 hours 20 minutes
MP3 192kbps ( /  /  /  / )	39 hours 45 minutes
MP3 128kbps ( / )	59 hours 35 minutes
MP3 48kbps(MONO)	159 hours

Memory card

REC Mode (REC Scene) (*3)	4 GB	8 GB	16 GB	32 GB
LPCM 44.1kHz/16bit	6 hours 5 minutes	12 hours 10 minutes	24 hours 20 minutes	48 hours 40 minutes
MP3 192kbps ( /  /  /  / )	44 hours 40 minutes	89 hours 25 minutes	178 hours	357 hours
MP3 128kbps ( / )	67 hours 5 minutes	134 hours	268 hours	536 hours
MP3 48kbps(MONO)	178 hours	357 hours	715 hours	1,431 hours

*1 For long-term continuous recording, a USB AC adaptor (not supplied) is required.

For details on the battery life, see [Battery life](#).

*2 The maximum recording time in this topic indicates an estimation and may vary depending on the specifications of the memory card.

*3 Recording scenes associated with the recording mode by default

IC Recorder
ICD-PX470

Maximum playback time/number of music files

The following lists the maximum playback time of a music file and the number of music files (*) by bit rate.

Bit rate	Playback time	Number of files
128 kbps	59 hours 35 minutes	893 files
256 kbps	29 hours 45 minutes	446 files

* Provided that MP3 files of 4 minutes each are transferred to the IC recorder.

IC Recorder
ICD-PX470

Battery life

The following lists the battery life(*1) for alkaline and rechargeable batteries by REC Mode.

Alkaline battery life

(Measured with continuous use of the Sony LR03 (size AAA) alkaline batteries.)

REC Mode	Recording	Playback with the built-in speaker(*2)	Playback with external headphones
LPCM 44.1kHz/16bit	Approx. 40 hours	Approx. 16 hours	Approx. 37 hours
MP3 192kbps	Approx. 55 hours	Approx. 18 hours	Approx. 43 hours
MP3 128kbps	Approx. 57 hours	Approx. 18 hours	Approx. 45 hours
MP3 48kbps(MONO)	Approx. 62 hours	Approx. 18 hours	Approx. 45 hours
Music file (MP3 128kbps)	-	Approx. 18 hours	Approx. 45 hours

Rechargeable battery life

(Measured with continuous use of the Sony NH-AAA series rechargeable batteries(*3).)

REC Mode	Recording	Playback with the built-in speaker(*2)	Playback with external headphones
LPCM 44.1kHz/16bit	Approx. 34 hours	Approx. 12 hours	Approx. 29 hours
MP3 192kbps	Approx. 40 hours	Approx. 14 hours	Approx. 34 hours
MP3 128kbps	Approx. 41 hours	Approx. 14 hours	Approx. 34 hours
MP3 48kbps(MONO)	Approx. 47 hours	Approx. 14 hours	Approx. 34 hours
Music file (MP3 128kbps)	-	Approx. 14 hours	Approx. 34 hours

*1 Measured value by the standard of JEITA (Japan Electronics and Information Technology Industries Association). The battery life may shorten depending on how you operate the IC recorder.

*2 When playing back music through the built-in speaker with the volume level set to 27

*3 Depending on the country or region of your purchase, some of the optional accessories are not available.

IC Recorder
ICD-PX470

Precautions

On power

DC 3.0 V: Use two LR03 (size AAA) alkaline batteries

DC 2.4 V: Use two NH-AAA rechargeable batteries

DC 5.0 V: when using USB AC adaptor

Rated current consumption: 500 mA

On safety

Do not operate the unit while driving, cycling or operating any motorized vehicle.

On handling

- Do not leave the unit in a location near heat sources, or in a place subject to direct sunlight, excessive dust or mechanical shock.
- Should any solid object or liquid fall into the unit, remove the batteries and have the unit checked by qualified personnel before operating it any further.
- When using your IC recorder, remember to follow the precautions below in order to avoid warping the cabinet or causing the IC recorder to malfunction.
 - Do not sit down with the IC recorder in your back pocket.
 - Do not put your IC recorder into a bag with the headphones/earphones cord wrapped around it and subject the bag to strong impact.
- Be careful not to allow water to splash on the unit. The unit is not waterproof. In particular, be careful in the following situations.
 - When you have the unit in your pocket and go to the bathroom, etc.
When you bend down, the unit may drop into the water and may get wet.
 - When you use the unit in an environment where the unit is exposed to rain, snow, or humidity.
 - In circumstances where you get sweaty. If you touch the unit with wet hands or if you put the unit in the pocket of sweaty clothes, the unit may get wet.
- Listening with this unit at high volume may affect your hearing. For traffic safety, do not use this unit while driving or cycling.
- You may feel pain in your ears if you use the headphones when the ambient air is very dry. This is not because of a malfunction of the headphones, but because of static electricity accumulated in your body. You can reduce static electricity by wearing non-synthetic clothes that prevent the emergence of static electricity.

On noise

- Noise may be heard when the unit is placed near an AC power source, a fluorescent lamp or a mobile phone during recording or playback.
- Noise may be recorded when an object, such as your finger, etc., rubs or scratches the unit during recording.

On maintenance

To clean the exterior, use a soft cloth slightly moistened in water. Then use a soft dry cloth to wipe the exterior. Do not use alcohol, benzine or thinner.

If you have any questions or problems concerning your unit, please consult your nearest Sony dealer.

Backup recommendations

To avoid potential risk of data loss caused by accidental operation or malfunction of the IC recorder, we recommend that you save a backup copy of your recorded files to a computer, etc.

On using a microSD card

- When formatting (initializing) a memory card, make sure to use the IC recorder to format it. Operations of the memory cards formatted with Windows or other devices are not guaranteed.
- If you format a memory card containing recorded data, the recorded data will be deleted. Be careful not to delete important data.
- Do not leave a memory card within the reach of small children. They might accidentally swallow it.
- Do not insert or remove a memory card during recording/playback/formatting. Doing so may cause a malfunction of the IC recorder.
- Do not remove a memory card while the “Accessing,” “Saving...” or “Please Wait” message is on the display window. Doing so may damage the data.
- Your IC recorder does not support microSDXC cards with the capacity of 64 GB or more.
- We do not guarantee the operations of all types of compatible memory cards with the IC recorder.
- You cannot use a ROM (read-only-memory) type or write-protected memory card.
- Data may be corrupted in the following cases:
 - When a memory card is removed or the IC recorder is turned off during a read or write operation.
 - When a memory card is used in locations subject to static electricity or electrical noise.
- We assume no responsibility for any loss or damage of recorded data.
- We recommend that you save a backup copy of the important data.
- Do not touch the terminal of a memory card with your hand or a metal object.
- Do not strike, bend or drop a memory card.
- Do not disassemble or modify a memory card.
- Do not expose a memory card to water.

- Do not use a memory card under the following conditions:
 - Locations beyond the required operating conditions, including locations, such as the hot interior of a car parked in the sun and/or in the summer, the outdoors exposed to direct sunlight, or a place near a heater.
 - Humid locations or locations with corrosive substances present.
 - When using a memory card, make sure to check the correct insertion direction into the memory card slot.
 - Do not put any adhesive label on a memory card as it may cause the card to be stuck in the slot.
-

Related Topic

- [Formatting the memory \(Format Built-In Memory/Format SD Card\)](#)

IC Recorder
ICD-PX470

Safety regulations

WARNING

Do not expose the batteries (battery pack or batteries installed) to excessive heat such as sunshine, fire or the like for a long time.

CAUTION

Risk of explosion if battery is replaced by an incorrect type. Dispose of used batteries according to the instructions.

- The recorded music is limited to private use only. Use of the music beyond this limit requires permission of the copyright holders.
- Sony is not responsible for incomplete recording/downloading or damaged data due to problems of the IC recorder or computer.
- Depending on the types of the text and characters, the text shown on the IC recorder may not be displayed properly on device. This is due to:
 - The capacity of the connected IC recorder.
 - The IC recorder is not functioning normally.
 - Content information is written in the language or the character that is not supported by the IC recorder.

Disposal of waste batteries and electrical and electronic equipment (applicable in the European Union and other European countries with separate collection systems)



This symbol on the product, the battery or on the packaging indicates that the product and the battery shall not be treated as household waste. On certain batteries this symbol might be used in combination with a chemical symbol. The chemical symbols for mercury (Hg) or lead (Pb) are added if the battery contains more than 0.0005% mercury or 0.004% lead. By ensuring these products and batteries are disposed of correctly, you will help prevent potentially negative consequences for the environment and human health which could otherwise be caused by inappropriate waste handling. The recycling of the materials will help to conserve natural resources.

In case of products that for safety, performance or data integrity reasons require a permanent connection with an incorporated battery, this battery should be replaced by qualified service staff only. To ensure that the battery and the electrical and electronic equipment will be treated properly, hand over these products at end-of-life to the applicable collection point for the recycling of electrical and electronic equipment. For all other batteries, please view the section on how to remove the battery from the product safely. Hand the battery over to the applicable collection point for the recycling of waste batteries. For more detailed information about recycling of this product or battery, please contact your local Civic Office, your household waste disposal service or the shop where you purchased the product or battery.

Notice for the customers: the following information is only applicable to equipment sold in the countries applying EU directives

This product has been manufactured by or on behalf of Sony Corporation, 1-7-1 Konan Minato-ku Tokyo, 108-0075 Japan. Inquiries related to product compliance based on European Union legislation shall be addressed to the authorized representative, Sony Belgium, bijkantoor van Sony Europe Limited, Da Vincilaan 7-D1, 1935 Zaventem, Belgium. For any service or guarantee matters, please refer to the addresses provided in the separate service or guarantee documents.

To prevent possible hearing damage, do not listen at high volume levels for long periods.



The validity of the CE marking is restricted to only those countries where it is legally enforced, mainly in the countries EEA (European Economic Area).

IC Recorder
ICD-PX470

Trademarks

- Microsoft, Windows, Windows Vista and Windows Media are registered trademarks or trademarks of Microsoft Corporation in the United States and/or other countries.
- Mac OS is a trademark of Apple Inc., registered in the USA and other countries.
- MPEG Layer-3 audio coding technology and patents licensed from Fraunhofer IIS and Thomson.
- microSD, microSDHC and microSDXC logos are trademarks of SD-3C, LLC.



All other trademarks and registered trademarks are trademarks or registered trademarks of their respective holders. Furthermore, “™” and “®” are not mentioned in each case in this Help Guide.

This product is protected by certain intellectual property rights of Microsoft Corporation. Use or distribution of such technology outside of this product is prohibited without a license from Microsoft or an authorized Microsoft subsidiary.

The “Sound Organizer 2” uses software modules as shown below:
Windows Media Format Runtime

IC Recorder
ICD-PX470

Notice for users

All rights reserved. This Help Guide or the software described herein, in whole or in part, may not be reproduced, translated or reduced to any machine readable form without prior written approval from Sony Corporation.
IN NO EVENT SHALL SONY CORPORATION BE LIABLE FOR ANY INCIDENTAL, CONSEQUENTIAL OR SPECIAL DAMAGES, WHETHER BASED ON TORT, CONTRACT, OR OTHERWISE, ARISING OUT OF OR IN CONNECTION WITH THIS HELP GUIDE, THE SOFTWARE OR OTHER INFORMATION CONTAINED HEREIN OR THE USE THEREOF.
Sony Corporation reserves the right to make any modification to this Help Guide or the information contained herein at any time without notice.

What you record is for personal enjoyment and use only. Copyright laws prohibit other forms of use without the permission of the copyright holders.

IC Recorder
ICD-PX470

License

Notes on the License

This IC recorder comes with software that are used based on licensing agreements with the owners of that software. Based on requests by the owners of copyright of these software applications, we have an obligation to inform you of the following. Please read the following sections.

Licenses (in English) are recorded in the internal memory of your IC recorder. Establish a Mass Storage connection between the IC recorder and a computer to read licenses in the "LICENSE" folder.

On GNU GPL/LGPL applied software

The software that is eligible for the following GNU General Public License (hereinafter referred to as "GPL") or GNU Lesser General Public License (hereinafter referred to as "LGPL") are included in the IC recorder.

This informs you that you have a right to have access to, modify, and redistribute source code for these software programs under the conditions of the supplied GPL/LGPL.

Source code is provided on the web. Use the following URL to download it.

<http://www.sony.net/Products/Linux/>

We would prefer you do not contact us about the contents of source code.

Licenses (in English) are recorded in the internal memory of your IC recorder. Establish a Mass Storage connection between the IC recorder and a computer to read licenses in the "LICENSE" folder.

IC Recorder
ICD-PX470

Customer support websites

Please access the following support home page to get the support information about your IC recorder:

For customers in Europe:

<http://www.sony.eu/DNA>

For customers in Latin America:

<http://www.sony-latin.com/index.crp>

For customers in the U.S.A.:

<http://www.sony.com/recordersupport>

For customers in Canada:

<http://www.sony.ca/ElectronicsSupport>

For customers in China:

<https://service.sony.com.cn>

For customers in other countries/regions:

<http://www.sony-asia.com/support>

Note that recorded files may be deleted during service or repair services.

IC Recorder
ICD-PX470

Troubleshooting

Before taking your IC recorder for repair, check it as follows.

- Check the items listed in “Troubleshooting.”
- Remove the batteries from the compartment and insert them back in.
Some problems may be solved when you remove the batteries from the compartment and insert them back in.
- Check the Sound Organizer 2 help.
For details on the operation of Sound Organizer 2, refer to the Sound Organizer 2 help.

Should any problem persist after you have made these checks, consult your nearest Sony dealer.

Please access the following support home page to obtain the latest support information about the IC recorder:

For customers in Europe:

<http://support.sony-europe.com/DNA>

For customers in Latin America:

<http://www.sony-latin.com/index.crp>

For customers in the U.S.A.:

<http://www.sony.com/recordersupport>

For customers in Canada:

<http://www.sony.ca/ElectronicsSupport>

For customers in China:

<https://service.sony.com.cn>

For customers in other countries/regions:

<http://www.sony-asia.com/support>

Note that recorded files may be deleted during repair services.

Related Topic

- [Customer support websites](#)
- [The Sound Organizer 2 window \(for Windows only\)](#)

IC Recorder
ICD-PX470

The recorded file is noisy and is hard to understand.

- Ambient noise is recorded as well as human voices.

If you apply the Clear Voice function (“Clear Voice 1” or “Clear Voice 2,”) to the playback audio, ambient noise in all frequency bands (noise from projectors or air conditioners, etc.) will be reduced to make human voices distinctive, and you will hear human voices more clearly.

While playback with the built-in speaker or playback of the files in “ Music” is in progress, however, the Clear Voice function does not work.

Related Topic

- [Reducing noise in the playback audio to make human voices sound clearer – the Clear Voice function](#)

IC Recorder
ICD-PX470

The recorded file is noisy and you want to record with less noise.

- With the Recording Filter function (“NCF(Noise Cut)” or “LCF(Low Cut)”), you can reduce noise in the recordings. Additionally, you can use the Scene Select function to change some recording settings, including the recording mode and the sensitivity level of the built-in microphones, at once by selecting one of the recording scenes.
-

Related Topic

- [Reducing noise during recording \(Recording Filter\)](#)
- [Selecting a recording scene for an individual situation](#)

IC Recorder
ICD-PX470

A rustling noise is recorded.

- If you accidentally touch your IC recorder or let an object come in contact with it while recording is in progress, rustling noises may be recorded. Keep your hand away from the IC recorder until you finish recording.

IC Recorder
ICD-PX470

A buzzing or humming noise is recorded.

- A buzzing or humming noise may be recorded if your IC recorder is placed near an AC power source, a fluorescent lamp, or a mobile phone during recording or playback.
Keep the IC recorder away from such devices when recording.

IC Recorder
ICD-PX470

Noise is recorded when you use an external microphone (not supplied) for recording.

- The plug of the connected external microphone is dirty.
Clean the plug.

IC Recorder
ICD-PX470

You hear noise when using headphones (not supplied) for playback.

- The plug of the connected headphones is dirty.
Clean the plug.

IC Recorder
ICD-PX470

The volume of the audio you recorded from an external device is low or you hear squeaking noises when you listen to the audio via the built-in speaker.

- If you record audio from a monaural external device that is connected to your IC recorder with a stereo connection cable, playing the recorded files may sound low in volume or make squeaking noises when you listen to the audio via the built-in speaker. This is because the left and right audio signal output is reversed in phase, and does not indicate a malfunction. Be sure to use an audio cable with a monaural plug to record audio from a monaural external device.

IC Recorder
ICD-PX470

You hear noise during playback even with the Clear Voice function turned on.

- While playback with the built-in speaker or playback of the files in “ Music” is in progress, the Clear Voice function does not work.

IC Recorder
ICD-PX470

The IC recorder does not turn on or pressing any button does not work.

- The batteries are running out of power. Replace them with new ones.
 - Make sure that the batteries are inserted with the correct polarity.
 - Your IC recorder is turned off.
Slide the HOLD•POWER switch to “POWER” and hold it until the display window turns on.
 - Your IC recorder is placed in the HOLD state.
Slide the HOLD•POWER switch to the center dot.
-

Related Topic

- [Inserting batteries](#)
- [Using the IC recorder with the USB AC adaptor](#)
- [Turning the power on](#)
- [Parts and controls](#)
- [Releasing the IC recorder from the HOLD state](#)

IC Recorder
ICD-PX470

The IC recorder does not turn off.

-
- Slide and hold the HOLD•POWER switch to “POWER” and hold it until “Power Off” appears on the display window.
-

Related Topic

- [Turning the power off](#)
- [Parts and controls](#)

IC Recorder
ICD-PX470

The IC recorder automatically turns off.

- The Auto Power Off function on your IC recorder is set to “10min” by default to save battery power. If you leave the IC recorder unused for 10 minutes, it will automatically turn off. You can change the current setting with the Settings menu.
-

Related Topic

- [Setting the time period before the IC recorder automatically turns off \(Auto Power Off\)](#)

IC Recorder
ICD-PX470

The battery life is short.

- The battery life listed in this Help Guide is based on playback with the volume level set to 27. The battery life may shorten depending on the usage of your IC recorder.
 - Your IC recorder still consumes slight battery power while no operations are in progress. If you do not intend to use the IC recorder for an extended period of time, it is recommended that you turn the power off. It is also recommended that you set “Auto Power Off” to a shorter period of time. This will help you save battery power in case you forget to turn off the power of the IC recorder.
 - You are using your IC recorder under the temperature of 5 °C (41 °F) or below where the battery wears quickly. This is due to the characteristics of the battery and does not indicate a malfunction.
 - Manganese batteries are inserted in the compartment. Your IC recorder does not support manganese batteries.
-

Related Topic

- [Turning the power off](#)
- [Setting the time period before the IC recorder automatically turns off \(Auto Power Off\)](#)
- [Battery life](#)

IC Recorder
ICD-PX470

The IC recorder does not operate correctly.

- Remove the batteries from the compartment and insert them back in.
 - You may have formatted the built-in memory of your IC recorder with a computer. Be sure to use the IC recorder for formatting.
-

Related Topic

- [Formatting the memory \(Format Built-In Memory/Format SD Card\)](#)

IC Recorder
ICD-PX470

The operation indicator does not light.

- “LED” is set to “OFF.”
Set “LED” to “ON.”
-

Related Topic

- [Turning the operation indicator on or off \(LED\)](#)

IC Recorder
ICD-PX470

You cannot record a file.

- The remaining recording time is insufficient.
-

Related Topic

- [Checking the remaining recording time \(Available Rec. Time\)](#)

IC Recorder
ICD-PX470

Recording is interrupted.

- The VOR function is turned on. To turn off the VOR function, set “VOR” to “OFF.”
-

Related Topic

- [Recording automatically in response to the input sound volume – the VOR function](#)

IC Recorder
ICD-PX470

The input audio volume is too loud or not loud enough when you record audio from an external device.

-
- Use an audio connection cable to connect your IC recorder to an external device and adjust the volume level on the external device.
 - If you use an audio connecting cable with high resistance, the recording volume will decrease. Use an audio connecting cable without resistance.

IC Recorder
ICD-PX470

The playback volume is low.

- The built-in speaker is provided mainly for checking recorded audio files. If you find the volume not loud enough or have difficulty in understanding what you hear, use headphones (not supplied).
 - The recording volume may be low. Check the sensitivity level of the built-in microphones and the Scene Select setting.
-

Related Topic

- [Selecting the sensitivity level of the built-in microphones \(Built-In Mic Sensitivity\)](#)
- [Selecting a recording scene for an individual situation](#)
- [Tips for better recording](#)

IC Recorder
ICD-PX470

You hear no sound from the built-in speaker.

- Headphones (not supplied) are connected to your IC recorder. Disconnect the headphones.

IC Recorder
ICD-PX470

You hear sound from the built-in speaker even when headphones (not supplied) are connected.

- When the headphones connection is loose, you may hear sound from the built-in speaker as well. Disconnect the headphones and connect them once again.

IC Recorder
ICD-PX470

Playback speed is too fast or too slow.

- The DPC (Digital Pitch Control) setting is set to “ON,” and you have changed the playback speed. Set the DPC (Digital Pitch Control) setting to “OFF,” or change the playback speed to normal.
-

Related Topic

- [Adjusting the playback speed – the DPC \(Digital Pitch Control\) function](#)

IC Recorder
ICD-PX470

You cannot divide a file.

- You need a certain amount of free space in the built-in memory to divide a file.
 - Because of the system limitations, you may not be able to divide a file at the very beginning or at the very end of the file.
 - You cannot divide files other than those recorded by the IC recorder (e.g. a file transferred from a computer).
-

Related Topic

- [Deleting a file](#)

IC Recorder
ICD-PX470

You cannot move a file.

- You cannot move files in “ Music” to another folder in the built-in memory or the microSD card.

Related Topic

- [Protecting a file](#)

IC Recorder
ICD-PX470

You cannot copy a file to a different folder.

-
- You cannot copy files in “ Music” to another folder in the built-in memory or the microSD card.

IC Recorder
ICD-PX470

The folder or file you created is not displayed.

- If you have created a folder or file on the computer, your IC recorder may fail to detect it depending on where you created it. For more information, see [Structure of folders and files](#).

IC Recorder
ICD-PX470

The recording date of a file appears as "----/--/--" or "--:--."

-
- The file may have been recorded by a model of the IC recorder other than ICD-PX470. The date and time recording format varies depending on the model.

IC Recorder
ICD-PX470

The clock setting is reset.

- Once you have removed the batteries from the compartment and inserted them back in or you have replaced the batteries with new ones, the Set Date/Time screen appears on the display window. On this screen, you see the date and time of the last operation you made with your IC recorder before you removed the batteries. Be sure to change the date and time to the current ones.

IC Recorder
ICD-PX470

The remaining recording time on the display window is shorter than the one displayed on the computer.

-
- As the remaining recording time on the display window is calculated by subtracting the memory capacity required for system operations from the remaining built-in memory capacity, it may not be consistent with the one that Sound Organizer 2 shows on the computer.

IC Recorder
ICD-PX470

The “Memory Full” message appears and you cannot start recording.

- The built-in memory is full.
Delete unnecessary files from the built-in memory, or copy some files to another microSD card or a computer and delete the files.
-

Related Topic

- [Deleting a file](#)

IC Recorder
ICD-PX470

The “File Full” message appears and you cannot operate the IC recorder.

- With both the built-in memory and the inserted microSD card, your IC recorder is capable of storing up to 5,000 folders and files all together in total.
Delete unnecessary files from the built-in memory, or copy some files to another microSD card or a computer and delete the files.
-

Related Topic

- [Deleting a file](#)

IC Recorder
ICD-PX470

The microSD card is not detected.

- Remove the microSD card and insert it in the correct orientation.
-

Related Topic

- [Inserting a memory card](#)

IC Recorder
ICD-PX470

A folder or file name appears in unreadable characters.

-
- Some characters you use on Windows Explorer or Mac Finder are not supported by your IC recorder. Folder and file names containing such characters appear in unreadable characters on the IC recorder.

IC Recorder
ICD-PX470

Copying a file takes time.

- If the size of a file is large, it takes a considerable time to finish copying. Wait until the copying finishes.

IC Recorder
ICD-PX470

The IC recorder is not detected by the computer and you cannot transfer folders/files from the computer.

- Disconnect your IC recorder from the computer and connect it once again.
 - If your IC recorder is connected to the computer with a USB hub (not supplied) or a USB extension cable (not supplied), remove the hub or cable and connect the IC recorder directly to a USB port on the computer.
 - With the computer that does not meet the system requirements described in this Help Guide, successful operations are not guaranteed.
 - Your IC recorder may not be detected by the computer, depending on the USB port. Try another USB port on the computer.
-

Related Topic

- [System requirements](#)
- [System requirements for Sound Organizer 2](#)

IC Recorder
ICD-PX470

The file you transferred from the computer does not appear on the IC recorder and you cannot play the file.

- Your IC recorder is capable of displaying up to 8 folder levels.
 - Your IC recorder supports the LPCM (.wav), MP3 (.mp3), WMA (.wma), and AAC-LC (.m4a) formats. Files in other formats may not be detected by the IC recorder. See the technical specifications of your IC recorder.
 - Your IC recorder is capable of detecting up to 5,000 folders and files all together in total. Delete unnecessary files and folders or copy some files to another microSD card or a computer and delete the files.
 - If you have created a folder or file on the computer, your IC recorder may fail to detect it depending on where you created it. For more information, see [Structure of folders and files](#).
-

Related Topic

- [Structure of folders and files](#)
- [Technical specifications](#)

IC Recorder
ICD-PX470

The computer does not start.

- If you start the computer with your IC recorder connected to the computer, the computer may freeze or may not start properly. Disconnect the IC recorder from the computer and start the computer once again.
-

Related Topic

- [Disconnecting the IC recorder from the computer](#)

IC Recorder
ICD-PX470

You cannot install Sound Organizer 2.

- The capacity of the computer's hard disk is insufficient.
Check the hard disk capacity.
 - You cannot install Sound Organizer 2 on the computer with the operating system that is not supported by the software.
Install the software on the computer with the supported operating system.
 - You are attempting to log on to Windows Vista, Windows 7, Windows 8.1, or Windows 10 with a Guest account.
Make sure to log on with a user name with computer administrator privileges.
-

Related Topic

- [System requirements for Sound Organizer 2](#)

IC Recorder
ICD-PX470

The IC recorder is not detected by Sound Organizer 2.

- Check if the software is successfully installed, and then check the connections with your IC recorder as follows:
 - When you are using a USB hub, remove the hub and connect the IC recorder directly to a USB port on the computer.
 - Disconnect and then connect the IC recorder once again.
 - Connect the IC recorder to another USB port.
 - The computer may be placed in sleep/hibernate mode.
Change the power saving mode settings to keep the computer in normal mode.
 - Save a backup copy of all of the data stored on the built-in memory or the microSD card of your IC recorder to the computer, and then format the built-in memory or the microSD card with the IC recorder.
-

Related Topic

- [Formatting the memory \(Format Built-In Memory/Format SD Card\)](#)

IC Recorder
ICD-PX470

The playback volume of the computer is low or you hear no audio from the computer.

- The computer has no sound board.
- The computer has no built-in speakers or no external speakers are connected.
- The volume of the computer is turned off.
- Turn up the volume of the computer. (Refer to the instruction manual of the computer.)
- You can change the volume of WAV files and save them using the Increase Volume feature of the Microsoft Sound Recorder.

IC Recorder
ICD-PX470

You cannot play or edit stored files.

-
- Sound Organizer 2 is only capable of playing files in the supported format. Depending on the file format, you cannot use part of editorial features of the software. Refer to the help files of Sound Organizer 2.
-

Related Topic

- [The Sound Organizer 2 window \(for Windows only\)](#)

IC Recorder
ICD-PX470

The counter or slider does not operate correctly or you hear noise.

- You may be attempting to play one of the divided files.
Save the file on the computer (*), and then transfer it to your IC recorder. The file data will be optimized.
 - * Select one of the file formats supported by the IC recorder to save the file.
-

Related Topic

- [Technical specifications](#)

IC Recorder
ICD-PX470

Operations slow down as the number of stored files increases.

-
- Regardless of the recording length of files, operations slow down as the total number of files stored on your IC recorder increases.

IC Recorder
ICD-PX470

The computer seems to freeze while a file is being saved, added, or deleted.

- It takes a longer time to copy or delete a large file.
Wait until the copying or deleting finishes.

IC Recorder
ICD-PX470

Sound Organizer 2 freezes during start-up.

- While the computer is accessing your IC recorder, do not disconnect any cables as it may cause unstable computer operations or data corruption.
- There may be a conflict between Sound Organizer 2 and another driver or application.

IC Recorder
ICD-PX470

List of messages

HOLD... Slide HOLD Switch to Activate.

All the buttons are disabled because your IC recorder is in the HOLD state to prevent unintentional operations. Slide the HOLD•POWER switch to the center dot to release the IC recorder from the HOLD state.

(See [Releasing the IC recorder from the HOLD state.](#))

Low Battery Level

You cannot format the memory or delete all the files in a folder because of insufficient battery power. Replace the batteries (size AAA) with new ones.

(See [Inserting batteries.](#))

Low Battery

Your IC recorder does not work because its batteries have worn out. Replace the batteries (size AAA) with new ones.

(See [Inserting batteries.](#))

SD Card Error

- An error was detected when you inserted a microSD card into the microSD card slot. Remove the microSD card and insert it once again. If this message keeps appearing, use a new microSD card.
- The microSD card is write-protected.
- You inserted a read-only microSD card. You cannot use the read-only microSD card on your IC recorder.

Memory Full

The remaining capacity of the built-in memory or the microSD card is insufficient. Delete some files and repeat the recording once again.

(See [Deleting a file.](#))

File Full

The sum of folders and files or the total number of files has reached the limit. You cannot create any more files. Delete some files and create the file once again.

(See [Deleting a file.](#))

Track Marks are Full

The number of track marks has reached the limit. You cannot add any more track marks. Delete some unnecessary track marks.

(See [Deleting a track mark.](#))

Built-In Memory Needs to be Formatted / SD Card Needs to be Formatted

- The built-in memory or the microSD card has been formatted by a computer. Your IC recorder cannot create the required management file for operations. Make sure that you use the IC recorder, not a computer, to format the built-in memory or the microSD card.
(See [Formatting the memory \(Format Built-In Memory/Format SD Card\)](#).)
- The built-in memory or the microSD card does not contain the REC_FILE folder. Formatting the built-in memory or the microSD card automatically creates the REC_FILE folder.
(See [Formatting the memory \(Format Built-In Memory/Format SD Card\)](#).)

Process Error

- Make a backup copy of your necessary data and use the IC recorder to format the built-in memory or the microSD card.
(See [Formatting the memory \(Format Built-In Memory/Format SD Card\)](#).)
- A file system error was detected in the built-in memory or the microSD card. It may have been formatted by a computer. Use your IC recorder to format the built-in memory or the microSD card.
(See [Formatting the memory \(Format Built-In Memory/Format SD Card\)](#).)
- If the above actions do not work, consult your nearest Sony dealer.

No folder

- The memory storage you selected as the move/copy destination does not contain any folders. Create a folder and repeat the operation once again.
(See [Creating a folder](#).)
- The REC_FILE folder does not contain any folders. Create a folder and repeat the operation once again.
(See [Creating a folder](#).)

No File

The folder you selected does not contain any files. There is no file that you move or copy.

No Track Marks

The file you selected does not have any track marks that you can delete. Selecting “At All Track Marks” for “Divide” with the OPTION menu does not work, either.

Cannot Format SD Card Because No SD Card Is Inserted

Your IC recorder does not have a microSD card inserted. Insert a microSD card.
(See [Inserting a memory card](#).)

No SD Card

Your IC recorder does not have a microSD card inserted. “Move to SD Card” and “Copy to SD Card” of the “Move/Copy File” operation do not work.

Cannot Add Additional Folders

- The sum of folders and files has reached the limit. You cannot create any more files. Delete some folders or files and create the folder once again.
(See [Deleting a file](#) and [Deleting a folder](#).)
- The sequential number of the folder name has reached the limit. Delete unnecessary folders and create the folder once again.
(See [Deleting a folder](#).)

Could Not Create Folder

- The microSD card is write-protected. Unlock the microSD card.
- A file system error was detected in the built-in memory or the microSD card. It may have been formatted by a computer. Use your IC recorder to format the built-in memory or the microSD card.
(See [Formatting the memory \(Format Built-In Memory/Format SD Card\)](#).)

Could Not Delete Folder

- The microSD card is write-protected. Unlock the microSD card.
- A file system error was detected in the built-in memory or the microSD card. It may have been formatted by a computer. Use your IC recorder to format the built-in memory or the microSD card.
(See [Formatting the memory \(Format Built-In Memory/Format SD Card\)](#).)

File Protected

The file you selected is protected or "read-only." You cannot delete the file. Use your IC recorder to remove protection from the file, or use a computer to clear the read-only property.

(See [Protecting a file](#).)

Protected Files Not Deleted

The file you selected is protected or "read-only." Use your IC recorder to remove protection from the file, or use a computer to clear the read-only property, and then delete the file once again.

(See [Protecting a file](#).)

Some Data Not Deleted

If the selected folder contains sub-folders, the sub-folders and their files will not be deleted.

Unknown Data

- This data is not in a file format that is supported by your IC recorder. The IC recorder supports LPCM(.wav)/MP3 (.mp3)/WMA(.wma)/AAC-LC(.m4a) files.
(See [Technical specifications](#).)
- You cannot play back copyright protected files.
- The file you selected is corrupted. You cannot play or edit it.

File in Format That Does Not Allow Editing

- You cannot divide the file that you edited using an application other than Sound Organizer 2.
- This data is not in a file format that is supported by your IC recorder. The IC recorder supports LPCM(.wav)/MP3 (.mp3)/WMA(.wma)/AAC-LC(.m4a) files.
(See [Technical specifications](#).)

Invalid Operation

- A file system error was detected in the built-in memory or the microSD card. It may have been formatted by a computer. Use your IC recorder to format the built-in memory or the microSD card.
(See [Formatting the memory \(Format Built-In Memory/Format SD Card\)](#).)
- The built-in memory has a bad block. You cannot write data on the card. You need to repair your IC recorder.

- The microSD card has a bad block. You cannot write data on the card. Replace the microSD card with a new one.
- The remaining capacity of the built-in memory or the microSD card is insufficient. You cannot rename any folder. Delete unnecessary folders or files and repeat the operation once again.
(See [Deleting a folder](#) and [Deleting a file.](#))
- The sequential number of the folder or file name has reached the limit. Delete unnecessary folders or files and repeat the operation once again.
(See [Deleting a folder](#) and [Deleting a file.](#))
- The file name exceeds the maximum number of characters. You cannot divide the file. Shorten the file name.
- There is a track mark immediately before or after the point where you want to divide the file. Selecting “At All Track Marks” for “Divide” with the OPTION menu does not work.
- There is a track mark near the beginning or end of the file. Selecting “At All Track Marks” for “Divide” with the OPTION menu does not work.
- You cannot divide the file at a point near the beginning or end of the file.
- There is a file with the same name that has track marks. You cannot move, copy, or divide the file.

New File

The recording file has reached the maximum size limit (4 GB for an LPCM file, and 1 GB for an MP3 file). The file will be divided automatically and recording will continue as a new file.

Cannot Divide - Exceeds Max Number of Files in Folder

The sum of files in a folder or the total number of files will exceed the limit. You cannot divide the file. Delete unnecessary files and divide the file once again.
(See [Deleting a file.](#))

Same File Name Exists

There already is a file with the same name. You cannot create more than one file with the same name.

System Error

A system error was detected for some reason. Consult your nearest Sony dealer.

Only Activated When Built-In Microphone Used

You are attempting to change the sensitivity level of the built-in microphones while your IC recorder has an external microphone connected. You can only make a change to “Built-In Mic Sensitivity” while the built-in microphones are active as the input source.
(See [Selecting the sensitivity level of the built-in microphones \(Built-In Mic Sensitivity\).](#))

Only Activated When External Input Used

You are attempting to change the audio input type to an external microphone while your IC recorder does not have it connected. You can only make a change to “Ext. Input Setting” while an external microphone is connected.
(See [Selecting the audio input type and the sensitivity level of the external microphone \(Ext. Input Setting\).](#))

Operation Invalid While Playing

You have selected a menu item on the OPTION or HOME menu that is not available for execution during playback. Stop playback

and select the item once again.

Operation Invalid While Recording

You have selected a menu item on the OPTION or HOME menu that is not available for execution during audio recording. Stop recording and select the item once again.

Deactivated When Audio IN Used

You are attempting to change the Recording Filter setting while “Ext. Input Setting” is set to “Audio IN.” The Recording Filter function does not work while “Audio IN” is selected.

(See [Selecting the audio input type and the sensitivity level of the external microphone \(Ext. Input Setting\)](#) and [Reducing noise during recording \(Recording Filter\)](#).)

Only Active When Built-In Mic Voice Sensitivity Is High/Medium/Low

You are attempting to select “Focused/Wide” under “Recording Settings” when the sensitivity level of the built-in microphones of your IC recorder is set to “For Music” or “Auto” under “For Music.” While “For Music” or “Auto” under “For Music” is selected, the “Focused” or “Wide” recording function does not work.

(See [Selecting the sensitivity level of the built-in microphones \(Built-In Mic Sensitivity\)](#) and [Selecting the recording function \(Focused/Wide\)](#).)

NCF Unavailable When Mic Sensitivity Is Set to For Music

You are attempting to select “NCF(Noise Cut)” under “Recording Filter” when the sensitivity level of the built-in microphones of your IC recorder is set to “For Music.” While “For Music” is selected, the “NCF(Noise Cut)” recording filter function does not work.

(See [Selecting the sensitivity level of the built-in microphones \(Built-In Mic Sensitivity\)](#) and [Reducing noise during recording \(Recording Filter\)](#).)

IC Recorder
ICD-PX470

System limitations

Due to some system limitations on your IC recorder, you may encounter the following issues that do not indicate malfunctions.

Music files are not displayed in the sequence you expected or you cannot play them in that sequence.

The music files you transferred from a computer to your IC recorder are sorted by meta-data track number or file name.

A recording file is divided automatically.

If the file size reaches the maximum limit (4 GB for an LPCM file, and 1 GB for an MP3 file) during recording, the file will be divided and some of the recording may be lost around the divided point.

All characters appear in uppercase.

Depending on the character combination, the folder name you entered on a computer may appear in uppercase on your IC recorder.

Unreadable characters or appear in the folder, title, artist, or file name.

You used the characters that your IC recorder is not capable of displaying. Do not use 2-byte characters.

The A-B repeat segment you specified is not where you intended.

This may occur in some files.

The remaining recording time decreases when you divide a file.

Your IC recorder uses some memory space for managing divided files, resulting in a decrease in the remaining recording time.